

# General catalogue



Aragonesa de Componentes Pasivos

The world we have  
is the result of our way of thinking.

Albert Einstein



Tarazona (Zaragoza)  
SPAIN





**Aragonesa de Componentes Pasivos, S. A. (ACP)**, based in Tarazona (Zaragoza) Spain, is a World recognized specialist in thick-film technology and its application in the field of variable resistance since 1988. Our products include angular position sensors, potentiometers and trimmers which can be found in the following markets: appliances, automotive and industrial.

ACP's expertise lays in the development, characterization and manufacturing of polymeric pastes (resistive, conductive and dielectric) and its deposition in a wide range of substrates. We are vertically integrated, we also design and manufacture the plastic and the metal components that make part of our final products, being experts in materials and manufacturing processes. Finally, we put together all these components in our automated assembly lines that feature the control of the electrical parameters of each and every finished product.

This expertise allows us to adapt our products for customers with special and demanding requirements, providing electromechanical tailor made solutions.

Our products are RoHS and Reach compliant, and we are certified by IQNet under ISO 9001 and IATF 16949.

ACP has a strong R&D department that includes mechanical, chemical, materials, electronics and electrical engineers and also holds collaborations with universities and research institutes. We count with a professional team that makes our flexibility and high service level a key part of our value proposition. Our Prototype Building Team is able to prepare samples in very short lead time.

#### **Equipment:**

- In-house designed fully automated assembly lines, with integrated automated control systems.
- Type C clean room (class 10.000), with screen-printing equipment.
- On line drying, curing and sintering furnaces.
- Convection curing furnaces.
- Laser trimmer.
- Reel to reel electroplating.
- Dies and presses for metal strip stamping.
- Plastic injection machines.
- Quality testing laboratory: climate chambers, profile projectors, mechanical life equipment, shakers...





Company certificates:

**ISO 9001**  
(ER-0205/1994)



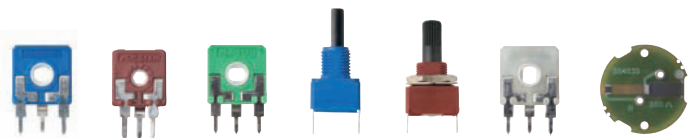

















**IATF 16949**  
(IATF: 0290599, RA02-0006/2005)



Sometimes we have ideas that seem to clash with the world, as we know it. But if we are willing to take a different approach and look at things from a different point of view; they might become a reality. This way of thinking confirms what we understood at ACP some time ago: to be innovative we need to look at things from a different perspective, we need to challenge the established standards. Facing this situation, we have reversed the first rule of industrial production: instead of designing to manufacturing, we manufacture for design. It is the only way to make ideas and the reality compatible and to come up with advanced concepts... We do know that there is no more powerful tool than imagination.





<b>1 General concepts</b>	9
<b>2 Potentiometers and sensors</b>	13
CA6  Carbon Potentiometers CA	14
CA9  Carbon Potentiometers CA	24
CA14  Carbon Potentiometers CA	38
CAR14  Carbon Potentiometers CAR	50
CE9  Cermet Potentiometers CE	24
CE14  Cermet Potentiometers CE	38
CER14  Cermet Potentiometers CER	50
RS9  Rotary Sensor	60
RS14  Rotary Sensor	72
RSR14  Rotary Sensor	82
CS14  Carbon Endless Sensor	90
Q16  Rotary Potentiometer Switch	102
QJ16  Spring Loaded Potentiometer	106
MCA9  Control Carbon Potentiometers CA	110
MCE9  Control Cermet Potentiometers CE	110
MCA14  Carbon Potentiometers CA	118
MCE14  Cermet Potentiometers CE	118
<b>3 Rotary Switches</b> 	128
<b>4 Thick film applications</b> 	136
<b>5 Special potentiometers</b> 	138



# 1 General concepts



# GENERAL CONCEPTS

## Potentiometer configuration

The pin that corresponds to the reading of the wiper is pin B.  
A and C are connected to the ends of the resistor, being pin A the initial position and C the final position.

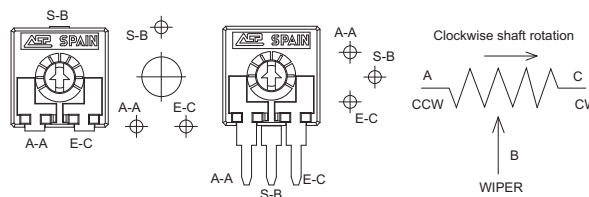

## Electric use

### Variable resistor

When pins A and B or C and B are connected, the current goes through the wiper (blue line).

Depending on where in the resistor the wiper is placed, it indicates a lower resistive value than the whole resistor would (we say it is used as variable resistor or rheostat).

The output is measured in ohms.

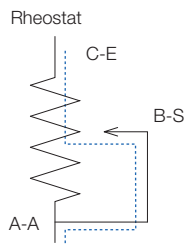

### Voltage divider

When a voltage is applied between the ends of the resistor (A and C), the current goes through the resistor, not the wiper.

The wiper sees a proportional share of the voltage applied between the ends (we say this is a Voltage Divider).

The output is a voltage, measured in V.

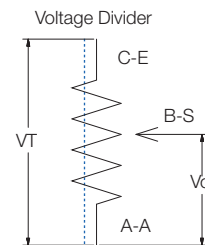

## Resistance

### Total resistance ( $R_T$ ):

It is the resistance found between the input terminal and the wiper when the latter is positioned to give the maximum value.

### Electric noise or contact resistance ( $R_c$ ):

Noise is any variation in the output signal that does not correspond to a similar variation in the input signal. It appears in the contact point between the resistive element and the wiper. It is measured in Ohms.

This noise can also be measured as "contact resistance variation" (CRV), which is expressed in the percentage of change between the initial resistance and the value of the resistance after a test. It is measured statically and dynamically. ACP's potentiometers have less than 5% CRV.

## ACP's standard resistive values

The standard values are as follows, although values out of range can also be studied.

100Ω	200Ω	220Ω	250Ω	470Ω	500Ω	1KΩ	2KΩ	2.2KΩ	2.5KΩ	4.7KΩ	5KΩ	10KΩ	20KΩ	22KΩ
100	200	220	250	470	500	1K	2K	2K2	2K5	4K7	5K	10K	20K	22K
25KΩ	47KΩ	50KΩ	100KΩ	200KΩ	220KΩ	250KΩ	470KΩ	500KΩ	1MΩ	2MΩ	2.5MΩ	4.7MΩ	5MΩ	
25K	47K	50K	100K	200K	220K	250K	470K	500K	1M	2M	2M5	4M7	5M	

## Variation laws - Tapers -

The standard taper is linear (A). Log (B) and Antilog (C) tapers are also available, as well as special tapers according to customer's specifications. For example, a special taper can be matched with a potentiometer with detents (click effect), to guarantee a value in a specific position – see below.-

ACP can also provide with tapers with different slopes, with areas with constant value or jumps, according to customer's specifications.

Special tapers can be combined with physical detents to match the areas where the customer wants to guarantee a constant value with a particular angular position. This is particularly suitable in applications which can benefit from a feeling of maintained control over the position, for example, regulation of temperature or speed.

### REGULAR TAPERS

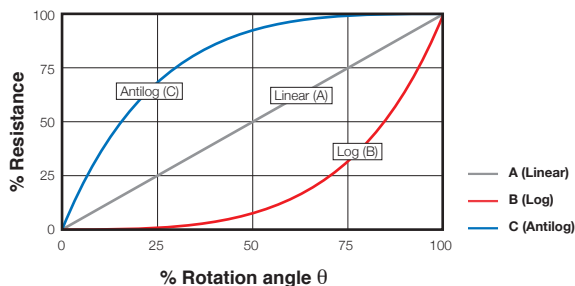

### SPECIAL TAPERS

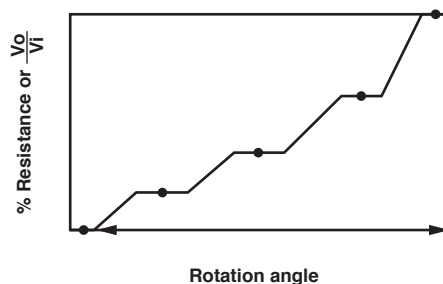

## Linearity

The term “linearity” implies that the real law obtained from plotting angular position vs voltage output is compared with a straight line.

### Independent Linearity (LN)

It is the maximum vertical deviation of the real law from the straight reference line chosen to best minimize the distance from the real line in any position.

It is expressed as a percentage of the total voltage applied.

In the graph below, “K” would be the maximum independent linearity and “k” the line with which the real law is compared.

### Absolute Linearity (LA)

It is the maximum vertical deviation of the real law from the straight reference line that runs through specified minimum and maximum points. These points would be zero and 100% of the maximum applied voltage.

In the graph below, “H” would be the maximum absolute linearity of the real law and “h” the theoretical line with which the real line is compared. When some customers are looking for correspondence of angle and value, this is the concept to consider.

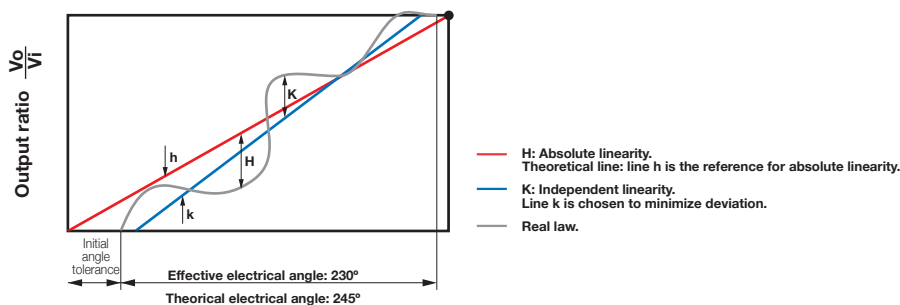

## Recommended soldering conditions

Soldering conditions (Lead free, RoHS compliant)\*

Manual soldering	Reflow soldering SMD	Flow (wave) soldering
Soldering tools of 20W max.	Preheating temperature: Max 150°C; 60-90 s	Recommended Alloy: SnAgCu
Maximum temperature of soldering tools: 280°C	Temperature Ramp-up: 2-3°C / s.	Preheating stage: Max 100°C; 30-60 s.
Time: 3 s. max.	Over 220°C: <40 s.	Temperature Ramp-up: 1.2-2.5°C/s.
	Solder temperature: 240°C for 5 ± 1 s.	Max. wave temp.: 260°C for 4s., (245°C recommended)
	Besides recommended conditions, ACP SMD potentiometers have successfully passed IEC 60068-2-58 tests.	Time within +0°-10°C of peak: 10s.
		Cooling rate: 5°C/s.

(\*) For other information on soldering conditions, please, contact us.

(For reflow soldering SMD) The conditions above are valid for one reflow pass only. For multiple passes, please, enquire.





## 2 Potentiometers and sensors

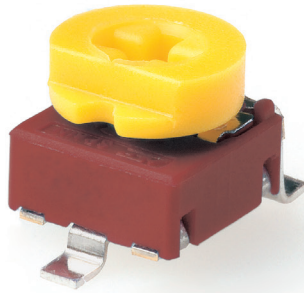
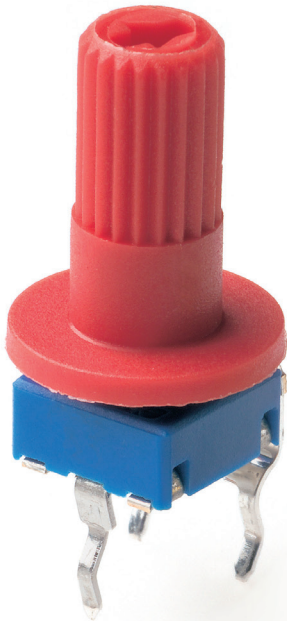

## CARBON – CA6

6mm carbon potentiometers with plastic housing and Ingress Protection rating type IP 54 (high level of protection against dust and also against water splashing), according to IEC 60529. Plastic materials can be self-extinguishable according to UL 94 V-0 under request.

Through-hole and SMD configurations are available. Terminals and collector are normally manufactured in tinned brass, although versions with steel terminals are also available under request. Terminals for through-hole models can be provided straight or crimped, which helps hold the component to the PCB during soldering.

Tapers can be linear, log and antilog; special tapers can also be studied.

ACP's potentiometers can be adjusted from either the front or the back, both in the horizontal and the vertical adjustment types. Thumbwheels and shafts can be ordered either separately or already inserted in the potentiometer.

Potentiometers can be manufactured in a wide range of possibilities regarding:

- Resistance value.
- Tolerance.
- Tapers / variation laws.
- Pitch.
- Positioning of the wiper (standard is at 50% rotation).
- Housing and rotor color.
- Mechanical life.
- Self-extinguishable plastic parts according to UL 94 V-0 under request.

### Applications

6mm potentiometers are mainly used in trimming applications, in different markets:

- Industrial: Timers and relays, dimmers, adjustment of output.
- Electronic appliances: volume regulation, temperature controls and function selection.
- Automotive: Lighting regulation, dimmers.
- Measurement and test equipment.
- Telecommunication equipment (antenna amplifiers and receivers, videocomm, intercomm).
- Alarm systems.



# CA6 HOW TO ORDER

EXAMPLE: **CA6XV2,5-10KA2020 SNP PI WT-6030-BA**

Standard features								Extra features					Assembled accessory				
Series	Rotor	Model	Packg.	Ohm value	Taper	Tol.	Life	Track	Snap in	Housing	Rotor	Wiper	Assembly	Ref #	Color	Flam.	
1	2	3	4	5	6	7	8	9	10	11	12	13	14				
CA6	X	V2,5		- 10K	A	2020		SNP				PI	WT	-6030	-BA		

Standard configuration:	CA6 Through-hole	CA6 SMD
Dimensions:	6mm	
Protection:	IP 54 (dust-proof) On request: Self-extinguishable, to meet UL 94 V-0	
Substrate:	Carbon technology	Carbon technology, special for high temperature
Color:	Blue housing + white rotor	Brown housing + grey rotor
Packaging:	Bulk or Tape & Reel	
Wiper position:	at 50% ±15°	
Terminals:	Snap in P (except model CA6VS5)	
Marking:	Resistive value marked on housing. Others on request.	

**Customized products:** A drawing is requested when ordering a customized product. Series, rotor, model and total resistive value are indicated before the code that includes all special specifications. Example: CA6XH2,5-10K CODE C00120.

## 1 - Series

■ CA6

## 2 - Rotors

D M N X

## 3 - Model and pitch

H2,5 HSMD V2,5 V5 VS5  
VSMD VESMD VSMD WT... VESMD WT...

## 4 - Packaging

	Trough-hole	SMD models
Bulk	(blank)... <sup>(1)</sup>	(blank)... <sup>(1)</sup>
T&R (Tape and 13" reel)	(N.A.) <sup>(2)</sup>	T&R
T&R (Tape and 15" reel)	(N.A.) <sup>(2)</sup>	T&R15

(1) If blank, bulk packaging is implied. (2) N.A., Not Applicable: Tape and Reel packaging is only available for SMD terminals.

## 5 - Resistance value

100Ω 200Ω 220Ω 250Ω 470Ω 500Ω 1KΩ 2KΩ ... 500KΩ 1MΩ 2MΩ 2M2Ω 4M7Ω 5MΩ  
100 200 220 250 470 500 1K 2K 500K 1M 2M 2M2 4M7 5M

## 6 - Resistance law / taper

Lin - Linear	A
Log - Logarithmic	B
Antilog - Antilogarithmic	C
- Special tapers have codes assigned:	CODE YXXXXX

## 7 - Tolerance

±20%	±25%	±30%	+50%,-30%	±10%	±5%
2020	2525	3030	5030	1010	0505

## 8 - Operating Life (Cycles)

Standard (1.000 cycles) (leave blank)  
Long life: LV + the number of cycles. ex: LV06 for 6.000 cycles. (others on request) LVXX: ex: LV06

## 9 - Cut Track - Open circuit.

Open circuit at beginning of track, fully CCW	PCI
Open circuit at end of track, fully CW	PCF

## 10 - Terminals

SNAP IN P	SNP
Shorter tip of terminal, TPXX, where XX is tip length (under request)	TPXX, ex: TP20
Steel Terminals	SH

## 11 - Housing

**Color:** For colors other than standard: -See color chart below- CJ-color, ex., red: CJ-RO

## 12 - Rotor

**Color:** For colors other than standard: -See color chart below- RT-color; ex., blue: RT-AZ

### \* Self-extinguishable property, V0, for housing and rotor:

By default, carbon is non self-extinguishable, cermet is Self-extinguishable: (blank)  
For carbon: self-extinguishable property can be added. V0 means housing V0  
and rotor are V0. If only the housing needs to be V0, then CJ-V0. CJ-V0, RT-V0  
If only rotor: RT-V0

## 13 - Wiper

<b>Wiper position</b> (Standard: 50% ± 15°)	(leave blank)
Initial or CCW	PI
Final or CW	PF
Others: following clock positions; at 3 hours: P3H	PXH, ex: P3H
<b>Wiper torque</b> (Standard: <2Ncm)	(leave blank)
Low torque, < 1.5Ncm	PGB

## 14 - Potentiometers with assembled accessories

Assembled from terminal side	WT
Assembled from collector side	WTI
Accessory Reference	-XXXXX
See list of shafts and thumbwheels available	Example: 6030
Color of shaft or thumbwheel	-YY Example, white: BA
Non self-extinguishable.	(leave blank)
Self-extinguishable according to standard UL 94	-V0
(-V0 in box 17 modifies only the accessory, please, note.)	

### For ordering spare accessories:

Accessory reference - color- flammability. XXXX-YY-V0  
Ex. 6030-AZ-V0 is a blue self-extinguishable 6030 thumbwheel

### Color chart for rotor, housing and accessories

Black <sup>(1)</sup>	White	Neutral	Transp.	Red	Green	Yellow	Blue	Grey	Brown
NE	BA	IN	TA	RO	VE	AM	AZ	GS	MR

(1) black is not an option for housings.

Rotors are drawn in their standard positioning, 50% of rotation. Alternative delivery positioning can be requested. Accessories in this catalogue are designed for the X rotor, unless otherwise stated.

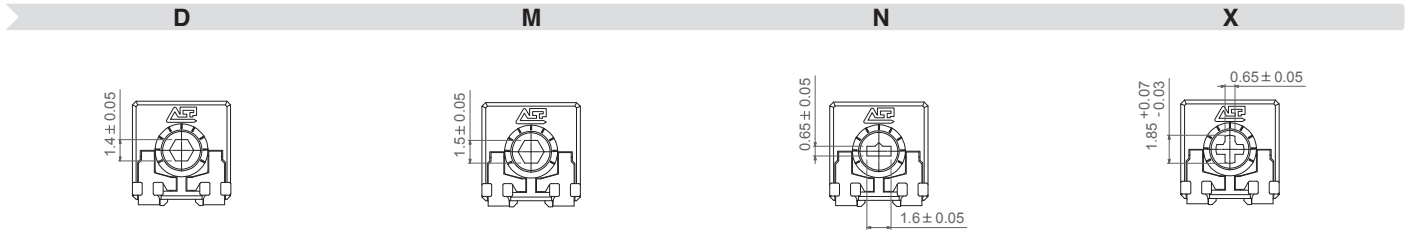

**Models**

All models shown here have the most common rotor for 6mm potentiometers: the X rotor. Different rotors are available from the menu above.

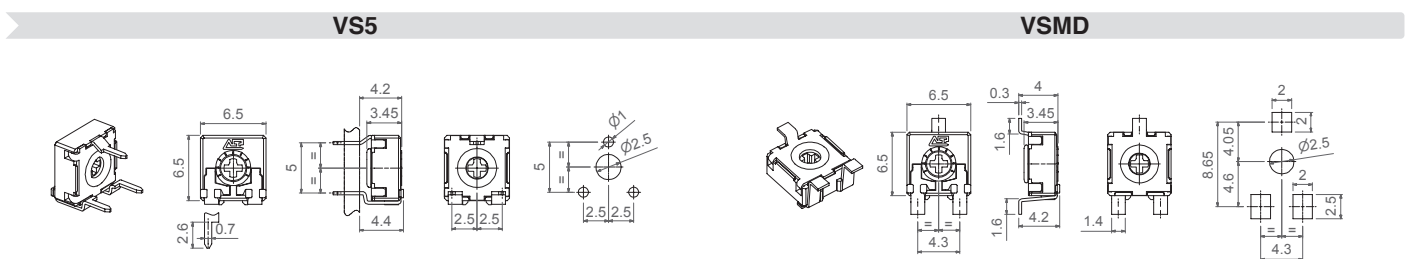
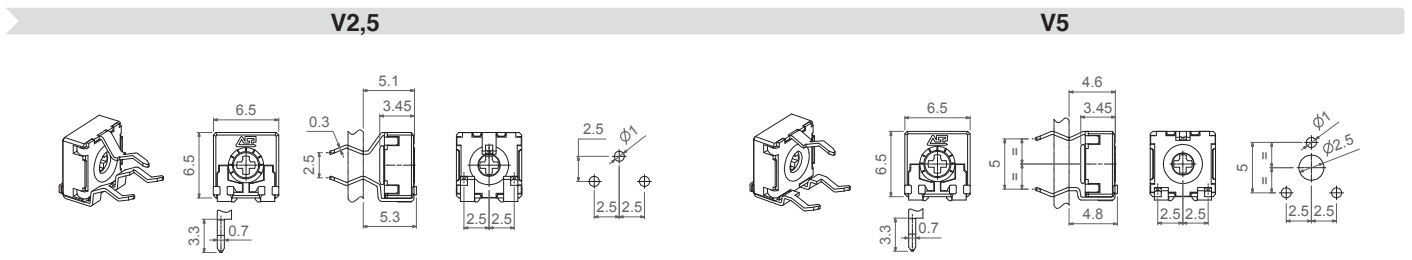
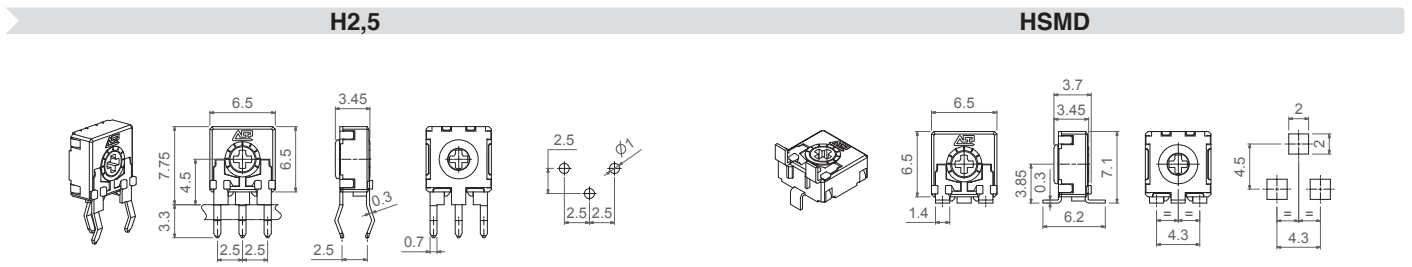

SNP not possible with VS5 model

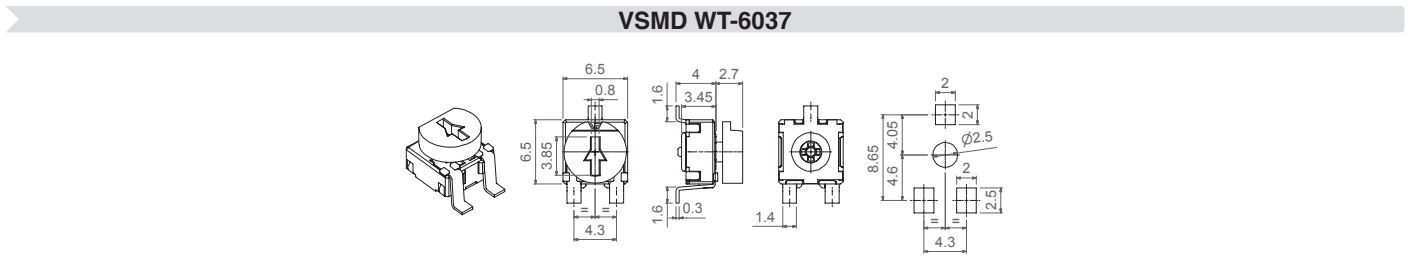
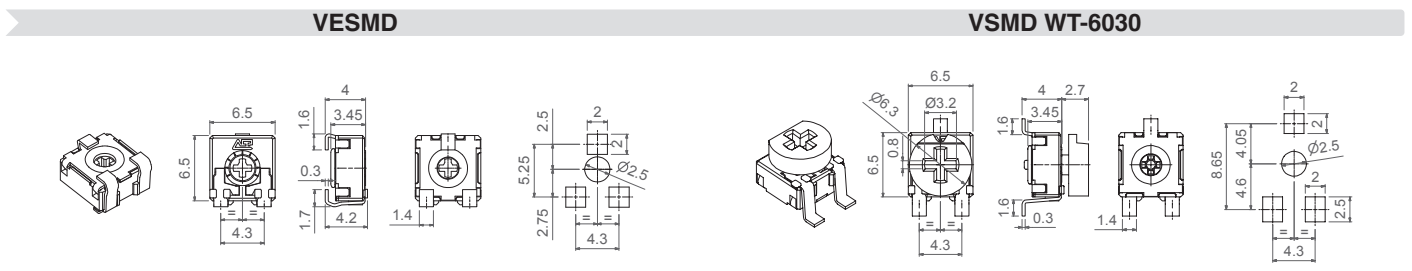

**Models**

**VESMD WT-6030**

**VESMD WT-6037**

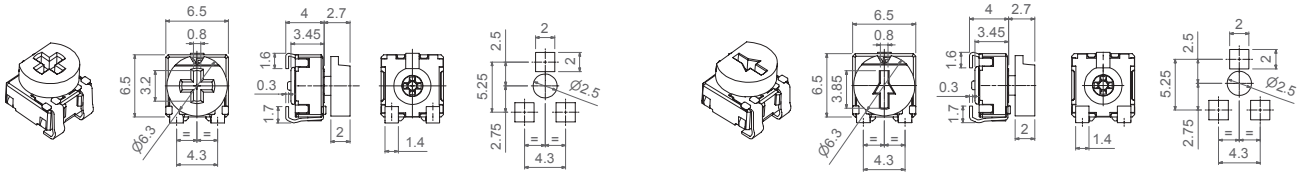

**Tapers**

The standard taper is linear (A). Log (B) and Antilog (C) tapers are also available, as well as special tapers according to customer's specifications.

**REGULAR TAPERS**

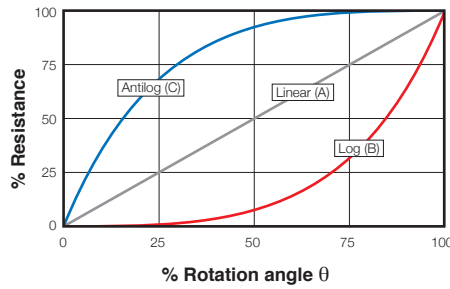

**Potentiometers with cut track**

The cut track is an area with very high resistive value, resulting in an open circuit. It is widely used in lighting applications.  
 PCI = Cut at initial position, when the potentiometer is turned fully counter clockwise.  
 PCF = Cut at final position, when the potentiometer is turned fully clockwise.  
 Other positions are available on request.

**PCI**

**PCF**

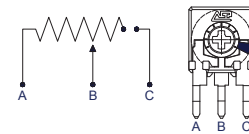
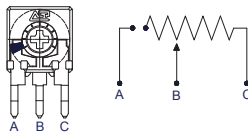

**Terminals**

By default, terminals are always crimped (with snap in, "SNP") to better hold the component to the PCB during the soldering operation, except for VS5, with short terminals that do not allow for SNP. ACP can provide straight terminals if needed.

**SNP**

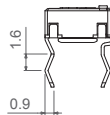

Also, there is an option of having shorter terminal tips.

**Possibilities for insertion of accessories**

Accessories can be mounted on potentiometers through either the front side (WT) or the collector side (WTI). For the specific angular position of shafts with planes, a drawing with the exact position is requested.

**WT Front side**

**WTI Collector side**

**WT Front side**

**WTI Collector side**

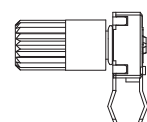
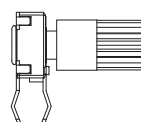
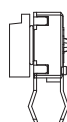
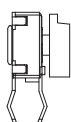

Shafts are available in different colors (color chart in “how to order” section) and with self-extinguishable property, according to UL 94 V-0, under request. ACP can study special shaft designs.

Shafts can be sold separately or delivered already mounted on the potentiometer at ACP.

When a shaft is mounted on a potentiometer, the distance from the top of the potentiometer to the top of the shaft is marked with “L” in the table below, as shown in the drawings:

**H potentiometer + shaft**

**V potentiometer + shaft**

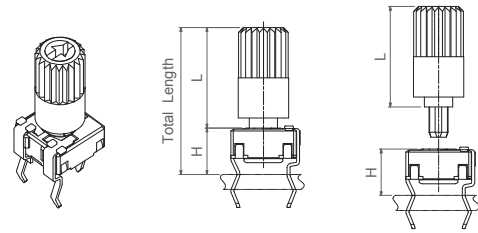
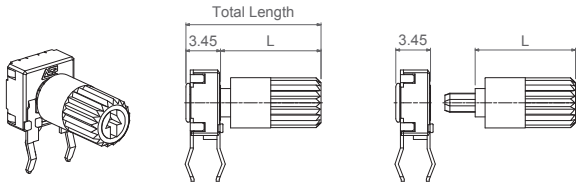

Shaft	6022	6023	6031	6024	6025	6028	6040
L Dimension	10	10	11	12.2	14.5	14.5	21.3

**6022**

**6023**

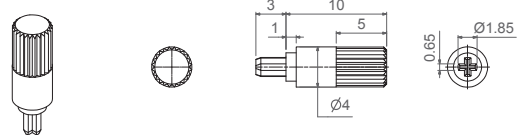
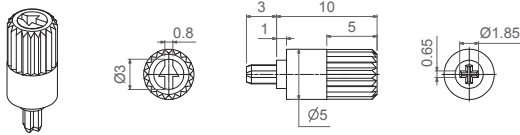

**6024**

**6025**

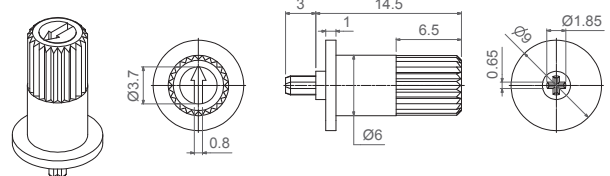
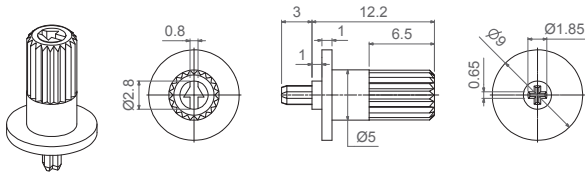

**6028**

**6031**

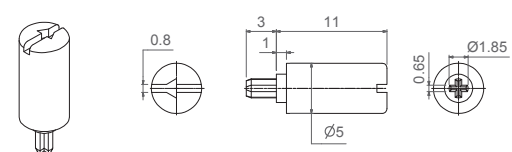
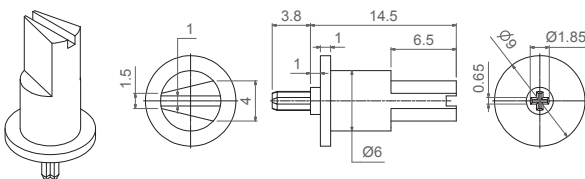

**6040**

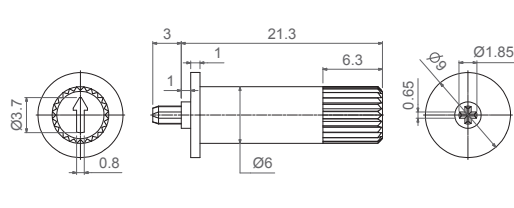

## Thumbwheel

Thumbwheels are available in different colors (color chart in "how to order" section) and with self-extinguishable property according to UL 94 V-0, under request.

Thumbwheels can be mounted on the potentiometers at ACP (see models with WT-6030 or WT-6037) or sold separately. ACP can study special thumbwheel designs.

**6001**

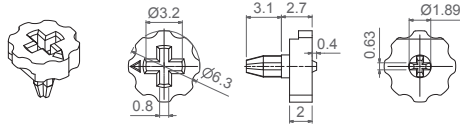

**6030**

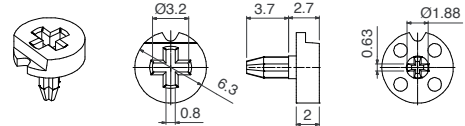

**6032**

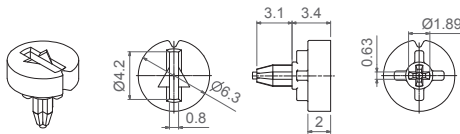

**6034**

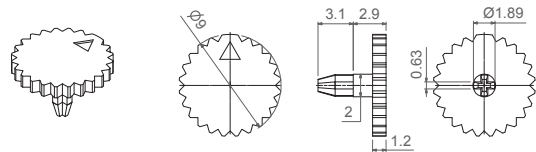

**6035 (Designed for M rotor)**

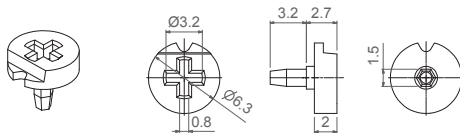

**6037**

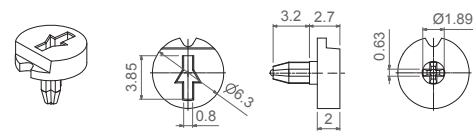

**6043**

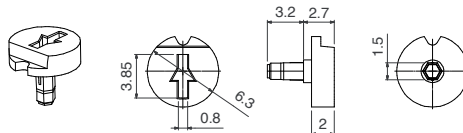

**Bulk packaging:**

Potentiometer model	With shaft or thumbwheel inserted?	Pieces per small box (150 x 100 x 70)	Pieces per bigger box (250 x 150 x 70, CG on description)
H2,5 - V2,5 - V5 VS5 - HSMD - VSMD - VESMD	None, only potentiometers.	1.000	4.000
	6001, 6030, 6032, 6035, 6037	1.000	3.000
	6024, 6025, 6028	300	To be determined.
	6022, 6023, 6031	500	To be determined.

**Tape & Reel packaging:**

	With thumbwheel inserted?	13" Reel (Standard), with 24mm width tape	15" Reel, with 24mm width tape
VSMD	None, only potentiometers.	1.200 pcs per reel, 12mm step between cavities.	1.700 pcs per reel, 12mm step between cavities.
	6030, 6035, 6037	750 pcs per reel, 12mm step between cavities.	1.100 pcs per reel, 12mm step between cavities.
VESMD	None, only potentiometers.	1.000 pcs per reel, 12mm step between cavities.	1.500 pcs per reel, 12mm step between cavities.
	6030, 6035, 6037	700 pcs per reel, 12mm step between cavities.	1.000 pcs per reel, 12mm step between cavities.
HSMD	None, only potentiometers.	750 pcs per reel, 12mm step between cavities.	1.000 pcs per reel, 12mm step between cavities.
	With specific thumbwheel.	Under request.	Under request.
VS5...PIP	None, only potentiometers.	900 pcs per reel, 12mm step between cavities.	1.200 pcs per reel, 12mm step between cavities.

The 13" reel is the standard. For the 15" reel, T&R15 is added to the description.

**VSMD-T&R**

**VSMD-T&R...WT-6030 / 6035 / 6037**

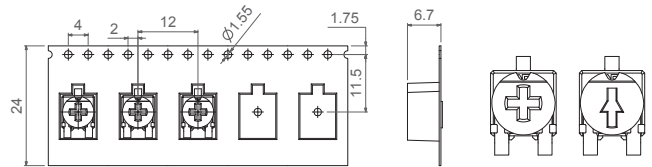
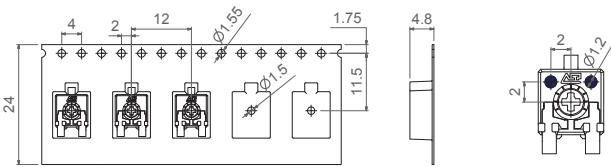

**VESMD-T&R**

**VESMD-T&R...WT-6030 / 6035 / 6037**

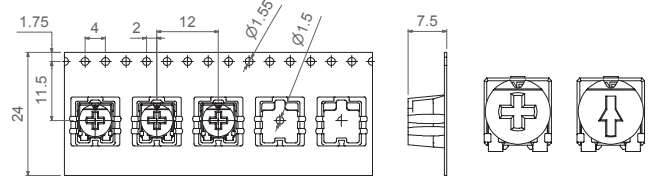
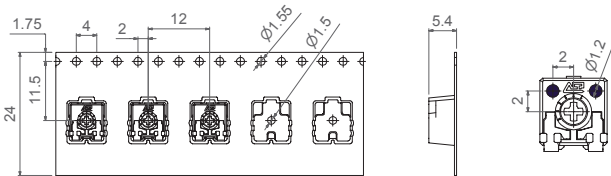

**HSMD-T&R**

**VS5-T&R...PIP**

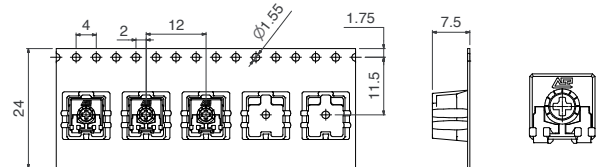
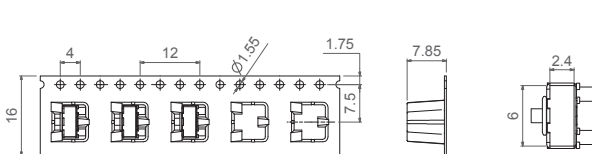

**13" Reel**

**15" Reel**

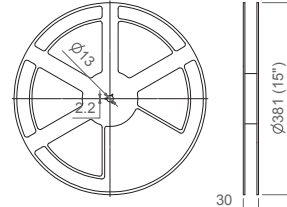
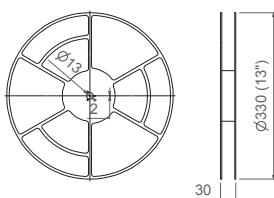

## Electric Specifications

These are standard features; other specifications and out of range values can be studied on request.

	CA6 Through-hole	CA6 SMD
Range of resistance values* Lin (A) Log (B) Antilog (C)	100Ω ≤ Rn ≤ 5MΩ 1 KΩ ≤ Rn ≤ 2M2Ω	100Ω ≤ Rn ≤ 1MΩ 1 KΩ ≤ Rn ≤ 1 MΩ
Tolerance* Rn < 100Ω: 100Ω ≤ Rn ≤ 100KΩ 100K < Rn ≤ 1MΩ: 1MΩ < Rn ≤ 5MΩ: Rn > 5MΩ:	+50%, -30% (out of range) ±20% ±20% ±30% +50%, -30% (out of range)	- ±25% ±25% ±50% -
Variation laws	Lin (A), Log (B), Antilog (C). Other tapers available on request	
Residual resistance	Lin (A), Log (B), Antilog (C) ≤ 5*10 <sup>-3</sup> *Rn. Minimum value 2Ω	
CRV - Contact Resistance Variation (dynamic)	Lin (A) Electrical Angle 215°±20° ≤ 3%Rn. Other tapers, please inquire	
CRV - Contact Resistance Variation (static)	Lin (A) Electrical Angle 215°±20° ≤ 5%Rn. Other tapers, please inquire	
Maximum power dissipation** Lin (A) Log (B), Antilog (C)	at 50°C 0.10W 0.06W	
Maximum voltage Lin (A) Log (B), Antilog (C)	100VDC 60VDC	
Operating temperature	-25°C ... +70°C (+85°C on request)	
Temperature coefficient 100Ω ≤ Rn ≤ 10KΩ 10KΩ < Rn ≤ 5MΩ	+200/ -300 ppm +200/ -500 ppm	+200/ -500 ppm +200/ -1000 ppm

\* Out of range ohm values and tolerances are available on request, please, inquire.

\*\* Dissipation of special tapers will vary, please, inquire.

## Mechanical Specifications

	CA6 Through-hole	CA6 SMD
Resistive element	Carbon technology	Carbon technology
Angle of rotation (mechanical)	235° ± 10°	
Angle of rotation (electrical)	215° ± 20°	
Wiper standard delivery position	50% ± 15°	
Max. stop torque	4 Ncm	
Max. push/pull on rotor	9.8 N	
Wiper torque*	<2 Ncm	
Mechanical life	1.000 cycles (others available on request)	

\* Stronger or softer torque feeling is available on request.

## Test results

The following typical test results are given at 23°C ±2°C and 50% ±25% RH.

### CA6 Through-hole and SMD

	Test conditions	Typical variation of nominal resistance
Damp heat	500 h. at 40°C and 95% RH	+5%, -2%
Thermal cycles	16 h at 85°C, plus 2 h at -25°C	±2.5%
Load life	1.000 h. at 50°C	+0%; -6%
Mechanical life	1.000 cycles at 10 c.p.m. and at 23°C ± 2°C	±4%
Storage (3 years)	3 years at 23°C ± 2°C	±3%

CA6 Through-hole and SMD

Power derating curve:

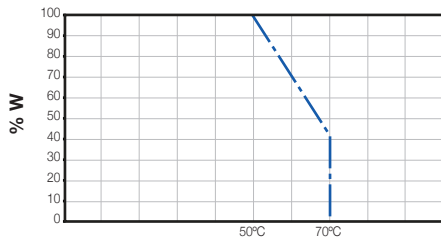

Representation of the typical variation of nominal resistance (with 95% confidence) throughout the ohm value range:

CA6 Through-hole and SMD

Damp heat

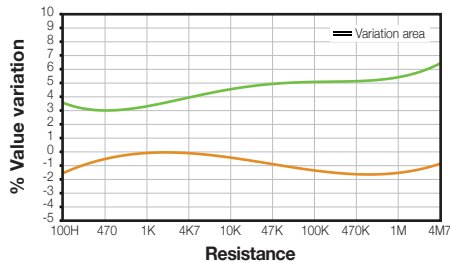

Temperature Coefficient

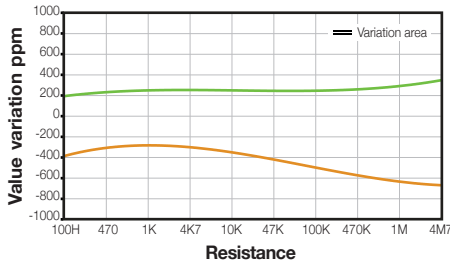

Load life

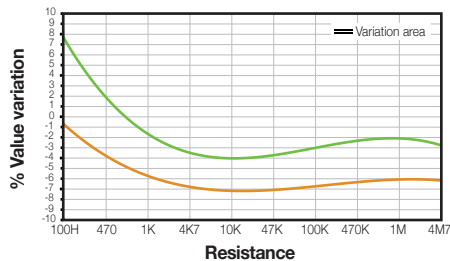

Mechanical life

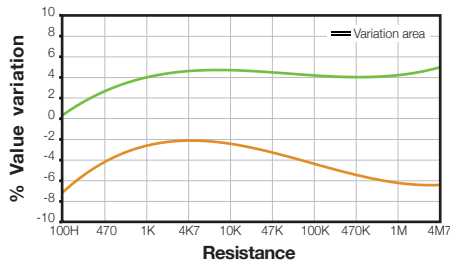



# CA9

Carbon Potentiometers CA

# CE9

Cermet Potentiometers CE



## CARBON – CA9

9mm carbon potentiometers with plastic housing and Ingress Protection rating type IP 54 (high level of protection against dust and also against water splashing), according to IEC 60529. Plastic materials can be self-extinguishable according to UL 94 V-0 under request.

Through-hole and SMD configurations are available. Terminals and collector are normally manufactured in tinned brass, although versions with steel terminals are also available under request. Terminals for through-hole models can be provided straight or crimped, which helps hold the component to the PCB during soldering.

Tapers can be linear, log and antilog; special tapers can also be studied.

ACP's potentiometers can be adjusted from either the front or the back, both in the horizontal and the vertical adjustment types. Thumbwheels and shafts can be ordered either separately or already inserted in the potentiometer.

Potentiometers can be manufactured in a wide range of possibilities regarding:

- Resistance value.
- Tolerance.
- Tapers / variation laws.
- Pitch.
- Positioning of the wiper (standard is at 50% rotation).
- Housing and rotor color.
- Mechanical life.
- Click effect (up to 20 detents available).
- Self-extinguishable plastic parts according to UL 94 V-0.

### Applications

9mm potentiometers are mainly used in control applications, in different markets:

- Industrial: Timers and relays, dimmers, adjustment of output.
- Electronic appliances: volume regulation, temperature controls and function selection.
- Automotive: Lighting regulation (position adjustment and sensing for headlights), dimmers, seat heating controls.

## CERMET – CE9

9mm cermet potentiometers with plastic housing and Ingress Protection rating type IP 54 (high level of protection against dust and also against water splashing), according to IEC 60529. Plastic materials (housing and rotor) are self-extinguishable according to UL 94 V-0 for ACP's cermet potentiometers.

Cermet potentiometers have better thermal stability, allow for higher thermal dissipation and withstand higher temperatures than carbon potentiometers.

Through-hole and SMD configurations are available. Terminals and collector are manufactured in tinned brass, although versions with steel terminals are also available under request. Terminals for through-hole models can be provided straight or crimped, which helps hold the component to the PCB during soldering.

Tapers can be linear, log and antilog; special tapers can also be studied.

ACP's potentiometers can be adjusted from either the front or the back, both in the horizontal and the vertical adjustment types. Thumbwheels and shafts can be ordered either separately or already inserted in the potentiometer.

Potentiometers can be manufactured in a wide range of possibilities regarding:

- Resistance value.
- Tolerance.
- Tapers / variation laws.
- Pitch.
- Positioning of the wiper (the standard is at 50%).
- Housing and rotor color.
- Mechanical life.
- Click effect (up to 20 detents available).

### Applications

9mm cermet potentiometers are used in applications where either the operating temperature is high, or where the application requires product with excellent ohmic value stability:

- Electronic appliances: temperature controls.
- Automotive: climate controls, position sensors, seat heating controls.
- Industrial electronics: multimeters, oscilloscopes, time relays, measurement and test equipment.

# CA9 CE9 HOW TO ORDER

EXAMPLE: **CA9MH2,5-10KA2020 SNP PI WT-9005-BA**

EXAMPLE: **CE9MH2,5-10KA2020 SNP PI WT-9005-BA-V0**

Standard features								Extra features							Assembled accessory			
Series	Rotor	Model	Packg.	Ohm value	Taper	Tol.	Life	Track	Detents	Snap in	Housing	Rotor	Wiper	Lin.	Assembly	Ref #	Color	Flam.
1	2	3	4	5	6	7	8	9	10	11	12	13	14	15	16			
CA9/CE9	M	H2,5		- 10K	A	2020				SNP			PI		WT	-9005	-BA	-V0

Standard configuration:	CA9 Through-hole	CA9 SMD	CE9 Through-hole and SMD
Dimensions:	9mm		
Protection:	IP 54 (dust-proof) On request: Self-extinguishable, to meet UL 94 V-0		
Substrate:	Carbon technology	Carbon technology, special for high temperature	Cermet
Color:	Blue housing + white rotor	Brown housing + grey rotor	Brown housing + white rotor
Packaging:	Bulk		
Wiper position:	at 50% ±15°		
Terminals:	Straight, without crimping.		
Marking:	Resistive value marked on housing. Others on request.		

**Customized products:** A drawing is requested when ordering a customized product. Series, rotor, model and total resistive value are indicated before the code that includes all special specifications. Example: CA9PH2,5-10K CODE C00111.

## 1 - Series

■ CA9 ■ CE9

## 2 - Rotors

C D E J K KA M MA MT P R Y

## 3 - Model and pitch

H2,5 H3,8 HS3,8 H5 HSMD V7,5 V10 VK10 VR10

MAV10 MTV10 VSMD VSMD WT-9002 VSMD...CY VSMD...CY WT-9002

## 4 - Packaging

### Trough-hole

### SMD models

Bulk (blank)...<sup>(1)</sup> (blank)...<sup>(1)</sup>

T&R (Tape and 13" reel) T&R T&R

T&R (Tape and 15" reel) T&R15 T&R15

(1) If blank, bulk packaging is implied.

## 5 - Resistance value

100Ω 200Ω 220Ω 250Ω 470Ω 500Ω 1KΩ 2KΩ ... 500KΩ 1MΩ 2MΩ 2M2 4M7Ω 5MΩ

100 200 220 250 470 500 1K 2K 500K 1M 2M 2M2 4M7 5M

## 6 - Resistance law / taper

Lin - Linear A

Log - Logarithmic B

Antilog - Antilogarithmic C

- Special tapers have codes assigned: CODE YXXXXX

## 7 - Tolerance

±20% ±30% +50%,-30% ±10% ±5%

2020 3030 5030 1010 0505

## 8 - Operating Life (Cycles)

Standard (1.000 cycles) (leave blank)

Long life: LV + the number of cycles. ex: LV10 for 10.000 cycles. (others on request) LVXX: ex: LV10

## 9 - Cut Track - Open circuit.

Open circuit at beginning of track, fully CCW PCI

Open circuit at end of track, fully CW PCF

Pin in Paste option (Reflow Soldering) PIP

## 10 - Detents (DT)

One detent at the beginning DTI

One detent at the end DTF

X number of detents XDT: 10DT

Special detents are available on request: If you need to assign a voltage value to each detent, please inquire.

## 11 - Terminals

SNAP IN P SNP

SNAP IN J SNJ

Shorter tip of terminal, TPXX, where XX is tip length (under request) TPXX, ex: TP25

Steel Terminals SH

## 12 - Housing

**Color:** For colors other than standard: -See color chart below- CJ-color, ex., red: CJ-RO

## 13 - Rotor

**Color:** For colors other than standard: -See color chart below- RT-color; ex., blue: RT-AZ

### \* Self-extinguishable property, V0, for housing and rotor:

By default, carbon is non self-extinguishable, cermet is self-extinguishable. (blank)  
For carbon: self-extinguishable property can be added. V0 means housing V0  
and rotor are V0 if only the housing needs to be V0, then CJ-V0. CJ-V0, RT-V0  
If only rotor: RT-V0

## 14 - Wiper

**Wiper position** (Standard: 50% ± 15°) (leave blank)

Initial or CCW PI

Final or CW PF

Others: following clock positions; at 3 hours: P3H PXH, ex: P3H

**Wiper torque** (Standard: <2.5Ncm, for detents: <3.5) (leave blank)

Low torque, < 1.5Ncm PGB

## 15 - Linearity

Not controlled (leave blank)

Independent linearity controlled & below x%, for example, 3%: LN3% LNx%; ex: LN3%

Absolute linearity controlled & below x% LAx%

## 16 - Potentiometers with assembled accessories

Assembled from terminal side WT

Assembled from collector side WTI

Accessory Reference -XXXXX

See list of shafts and thumbwheels available Example: 9010

Color of shaft or thumbwheel -YY Example, white: BA

Non self-extinguishable. (leave blank)

Self-extinguishable according to standard UL 94 -V0

(-V0 in box 17 modifies only the accessory, please, note.)

### For ordering spare accessories:

Accessory reference - color- flammability. XXXX-YY-V0

Ex. 9010-AZ-V0 is a blue self-extinguishable 9010 thumbwheel

### Color chart for rotor, housing and accessories

Black <sup>(1)</sup>	White	Neutral	Transp.	Red	Green	Yellow	Blue	Grey	Brown
NE	BA	IN	TA	RO	VE	AM	AZ	GS	MR

(1) black is not an option for housings.

## Rotors

Rotors are drawn in their standard positioning, 50% of rotation. Alternative delivery positioning can be requested. Accessories in this catalogue are designed for the M rotor, unless otherwise stated.

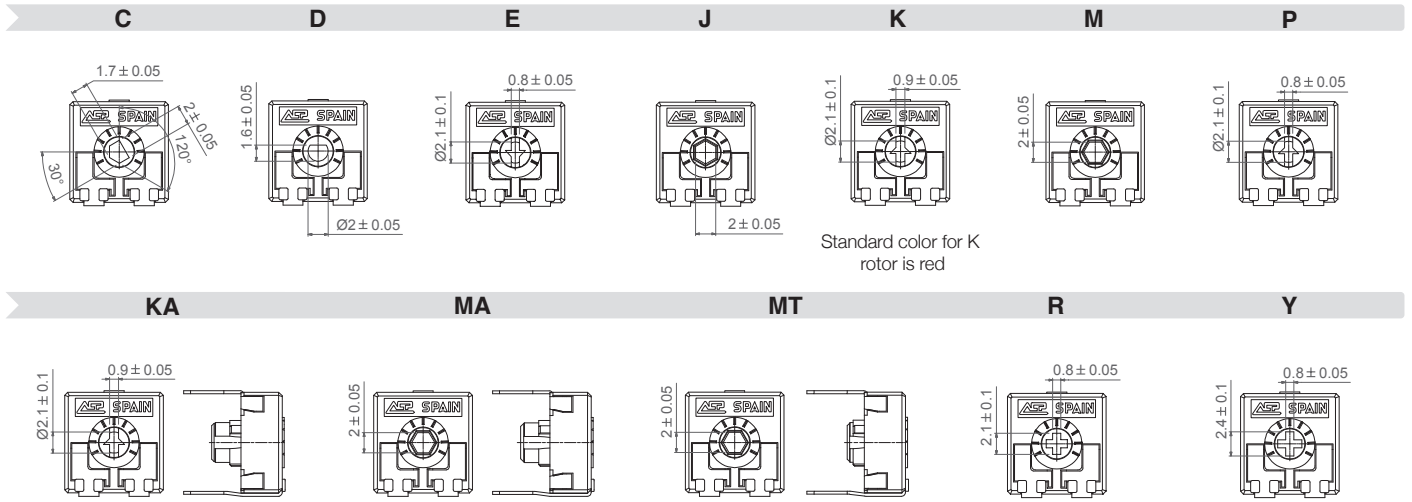

## Models

All models shown here have the most common rotor for 9mm potentiometers: the M rotor. Different rotors are available from the menu above.

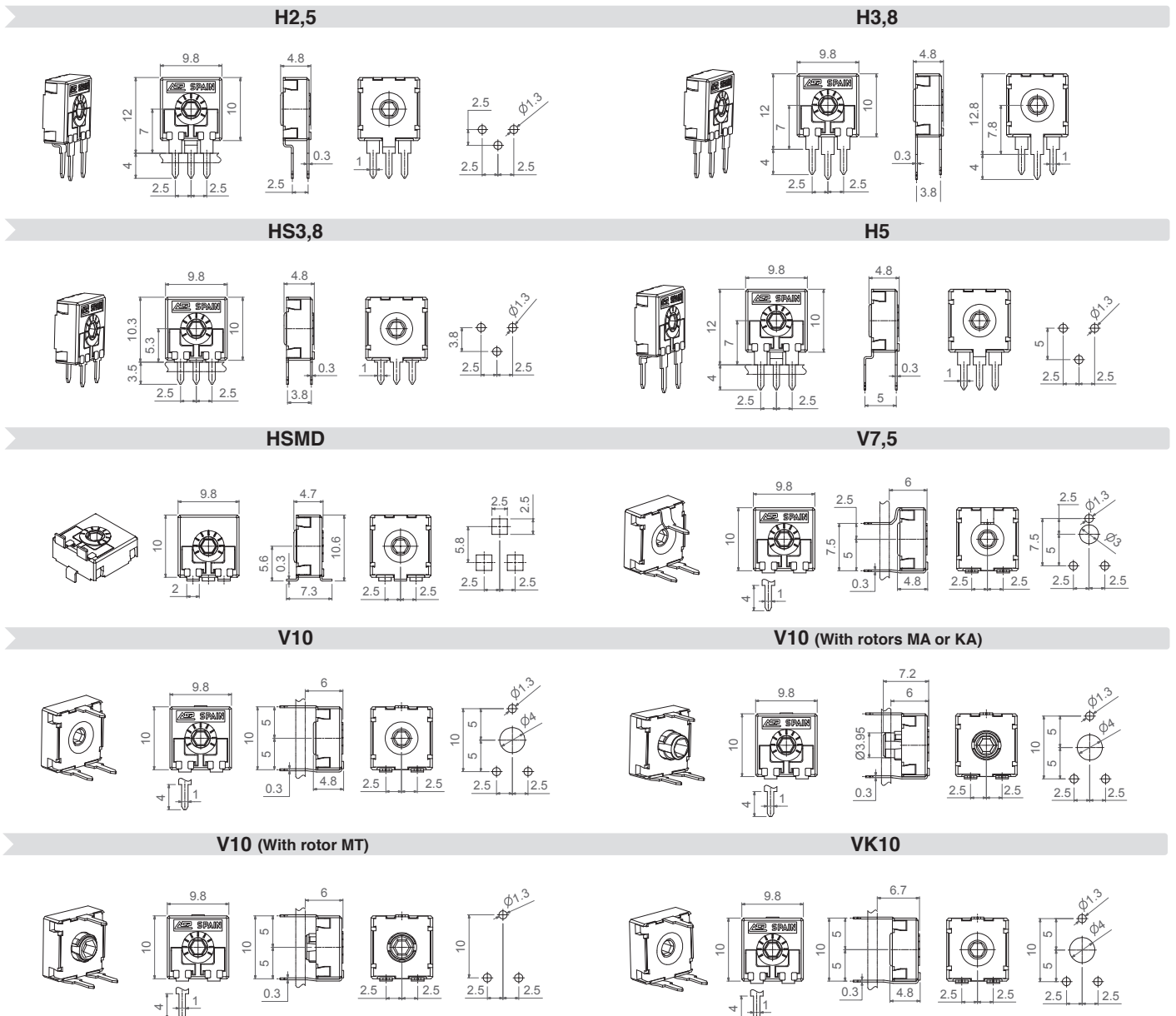

VR10

VSMC

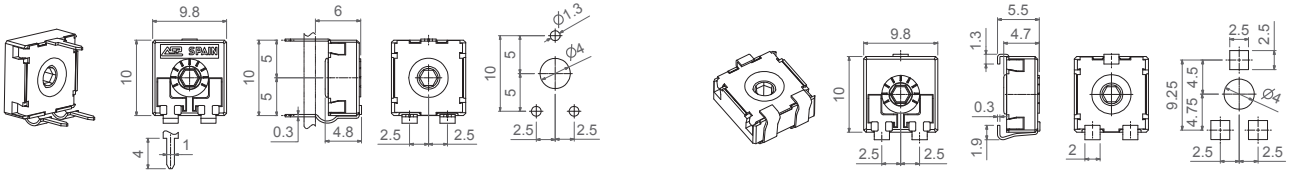

VSMC WT-9002

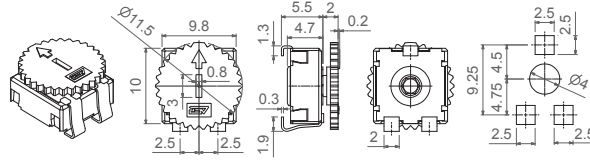

VSMC...CY

VSMC...CY WT-9002

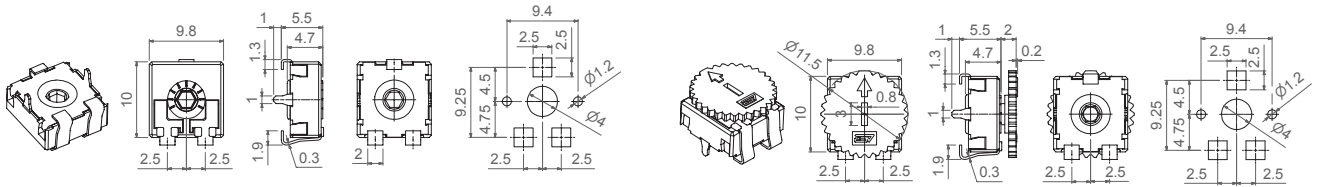

GANGED

GANGED: Set of potentiometers in a row that allows for simultaneous adjustment of all of them through one shaft. Recommended potentiometer model is H2.5. MTX2 (2 potentiometers), MTX4 (4), MTX6 (6), MTX8 (8).

Model	MTX2	MTX4	MTX6	MTX8
Shaft	9048, 9074, 9076	9039, 9051	9018	9056

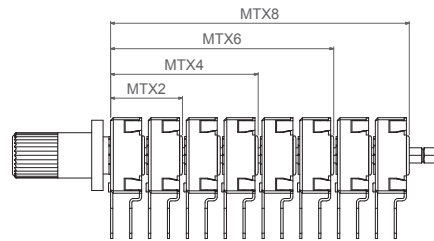

Tapers

The standard taper is linear (A). Log (B) and Antilog (C) tapers are also available, as well as special tapers according to customer's specifications. For example, a special taper can be matched with a potentiometer with detents (click effect) to guarantee a value in a specific position – see “detents” section.-

REGULAR TAPERS

SPECIAL TAPERS

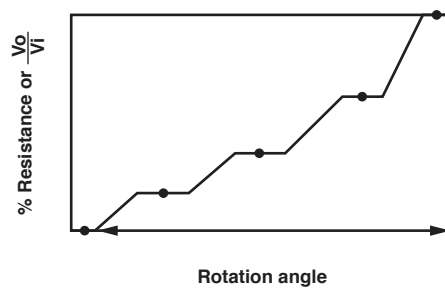
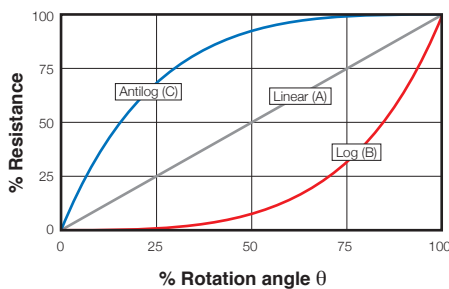

## Potentiometers with cut track

The cut track is an area with very high resistive value, resulting in an open circuit. It is widely used in lighting applications. Mechanical life with cut track needs to be confirmed.  
 PCI = Cut at initial position, when the potentiometer is turned fully counter clockwise.  
 PCF = Cut at final position, when the potentiometer is turned fully clockwise.  
 Other positions are available on request.

### PCI

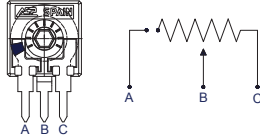

### PCF

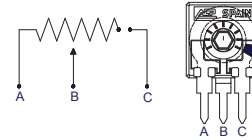

## Potentiometers with detents

ACP's patented detent (DT) feature is especially suitable for control applications where the end user will turn a knob inserted in the potentiometer. Detents can be used to add a click feeling to the turning of the potentiometer or to control the position in which the wiper is placed, assuring a particular output value with a narrow tolerance.

Detents can be light or strong, or even a combination of different feelings. They can be evenly distributed along the angle (standard) or tailored to match customers' request. They can also be combined with special tapers: constant value areas, open circuit zone, different slopes, etc. One common example is a potentiometer with detents and matching non-overlapping voltage values in specific angular positions, used to feed in a voltage value to a microprocessor:

### Example of 5DT with control of value in each DT.

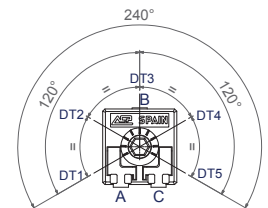
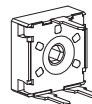
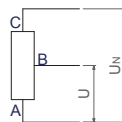
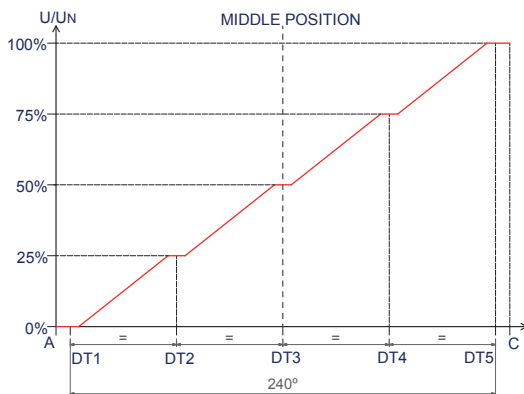

Other examples of potentiometers with detents:

### 10DT

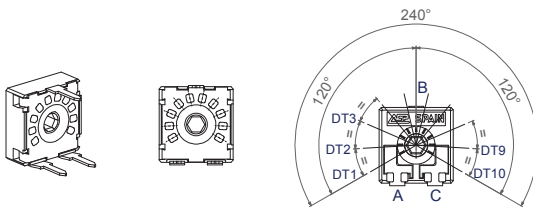

### 20DT

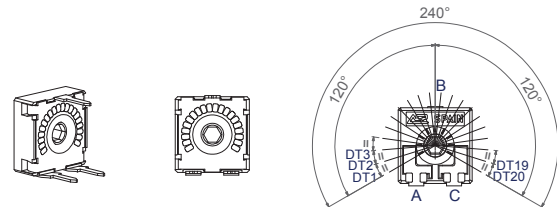

Number of standard detents (evenly distributed) already available.

1 (initial or final), 2 DT (initial and final), 3, 4, 5, 6, 7, 8, 10, 20.

Maximum number of detents for feeling only

20

Maximum number of detents when the voltage value in each detent is controlled and non-overlapping.

10

Our patented design with two wipers has improved the performance of these potentiometers, giving them more stable electrical parameters, improved reliability and Contact Resistance Variation (CRV) as well as narrower tolerances for detent positioning.

For potentiometers with detents, mechanical life is also 1.000 cycles if no additional cycles are mentioned. Please, indicate the number of cycles needed with LV (number of cycles), for example: LV07, for 7.000 cycles.



## Terminals

By default, terminals are always straight, as shown on the “models” section. ACP can provide crimped terminals (with snap in, “SNP” or “SNJ”) to better hold the component to the PCB during the soldering operation.

### SNP

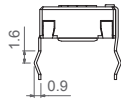

### SNJ

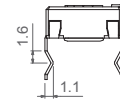

Also, there is an option of having shorter terminal tips:

### Standard Terminal

### Shorter terminal, for H5 TP25

### Shorter terminal, TPXX (under request)

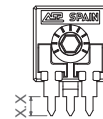
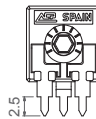
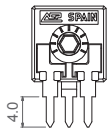

## Possibilities for insertion of accessories

Accessories can be mounted on potentiometers through either the front side (WT) or the collector side (WTI). For the specific angular position of shafts with planes, a drawing with the exact position is requested.

### WT Front side

### WTI Collector side

### WT Front side

### WTI Collector side

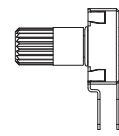
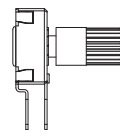
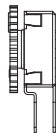
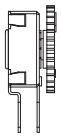

## Shafts

Shafts are available in different colors (color chart in “how to order” section) and with self-extinguishable property, according to UL 94 V-0, under request. ACP can study special shaft designs.

Shafts can be sold separately or delivered already mounted on the potentiometer at ACP.

Unless otherwise stated, the arrow in the shafts is in line with the wiper and it points to 50% when assembled with M rotors.

When a shaft is mounted on a potentiometer, the distance from the top of the potentiometer to the top of the shaft is marked with “L” in the table below, as shown in the drawings:

### H potentiometer + shaft

### V potentiometer + shaft

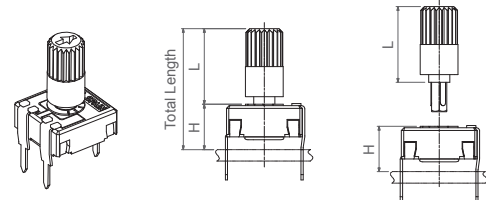
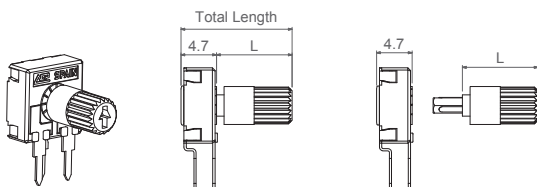

Shaft	9071	9067	9072	9074	9054	9004	9005	9064	9055	9070	9076	9053	9018	9039	9048	9056	9009	9059	9063	9010	9051	9006	9019	9073	9020	9047
L Dimension	3.5	5.5	6.5	9.3	9.5	10	10	10	10.8	11.9	12	12.1	12.8	12.8	12.8	14.5	14.5	14.5	15	15	19.7	19.9	25.5	25.9	29.8	

### 9004

### 9005

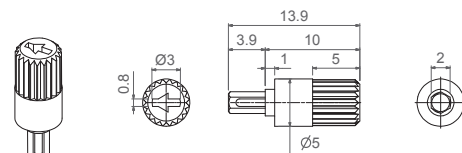
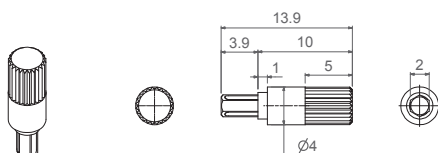

9006

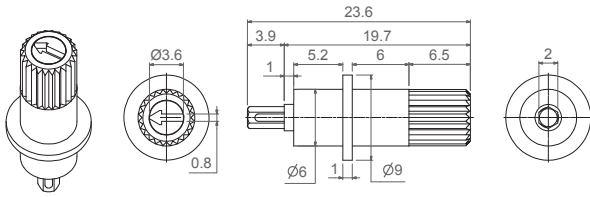

9009

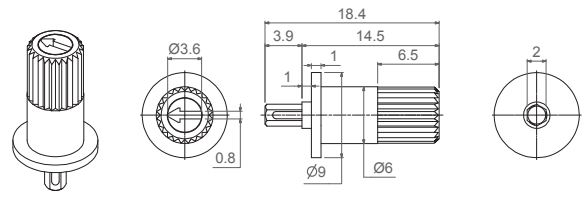

9010

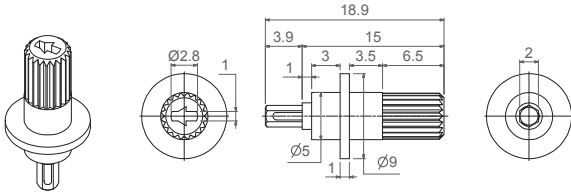

9018 (for 6 ganged potentiometers)

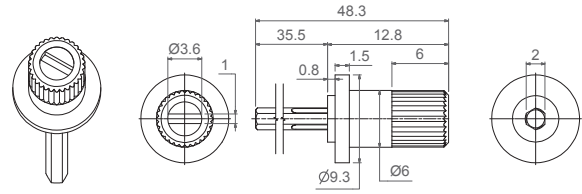

9019 (Designed for D rotor)

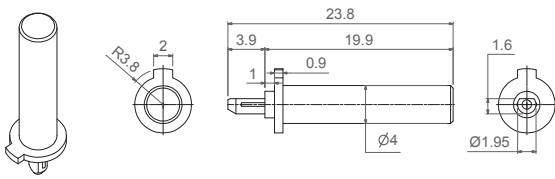

9020 (Designed for D rotor)

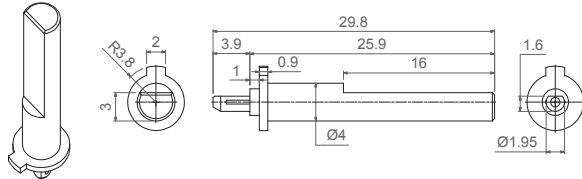

9039 (for 4 ganged potentiometers)

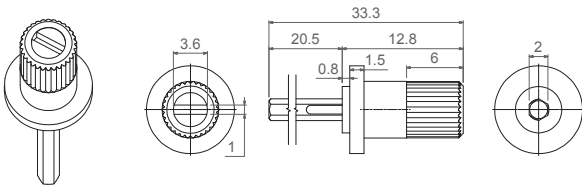

9047

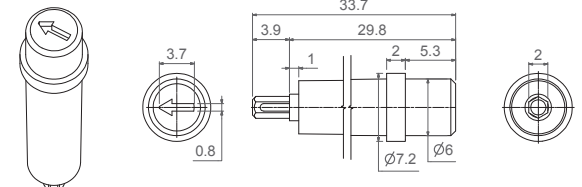

9048 (for 2 ganged potentiometers)

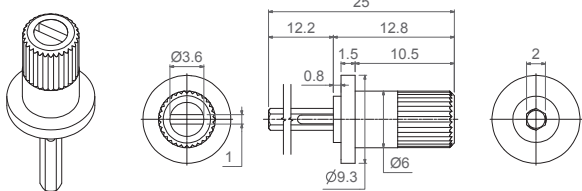

9051 (for 4 ganged potentiometers)

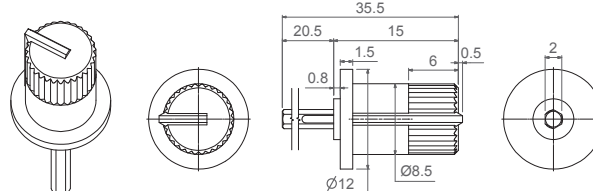

9053

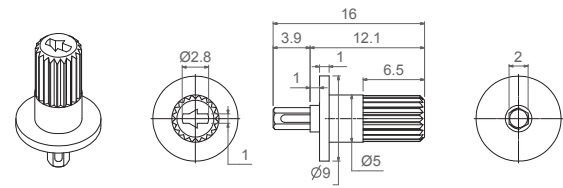

9054

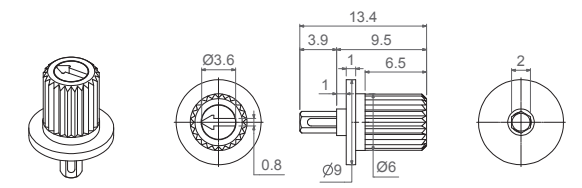

9055

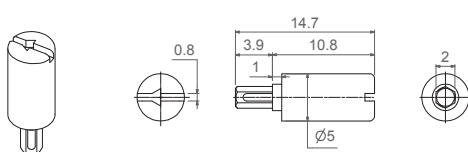

9056 (for 8 ganged potentiometers)

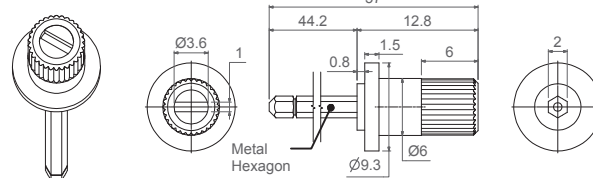

9059

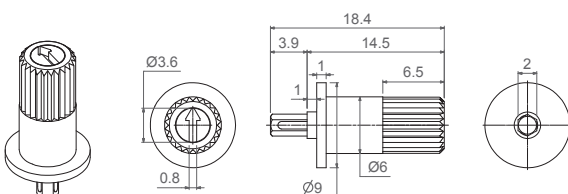

9063

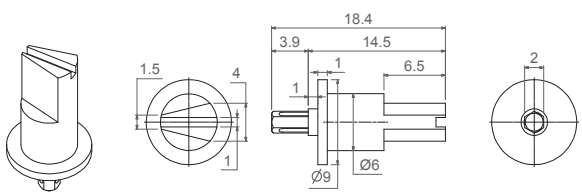

The arrow is in line with the wiper when potentiometer has rotor J (with M rotor, there is a 30° difference).

Specifications on this catalog are for reference only, as they are subject to change without notice.



**9064**

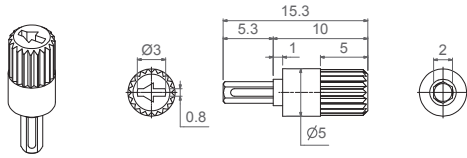

**9067**

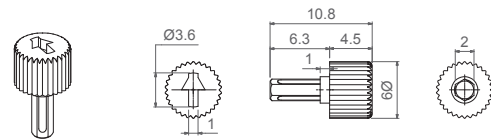

The arrow is in line with the wiper when potentiometer has rotor J (with M rotor, there is a 30° difference).

**9070**

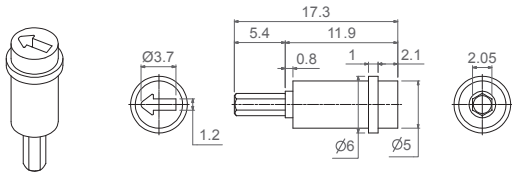

**9071**

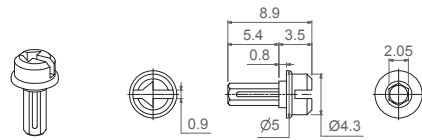

**9072**

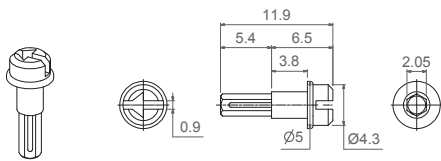

**9073**

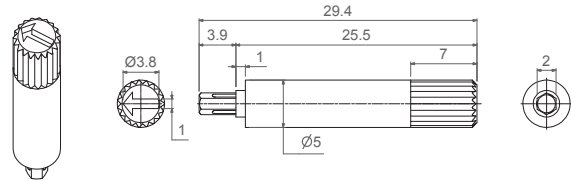

**9074 (for 2 ganged potentiometers)**

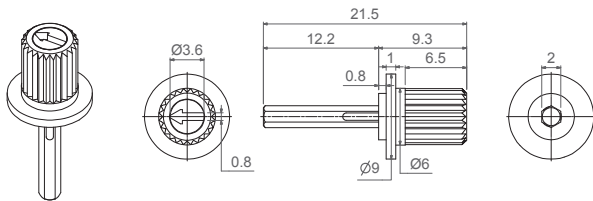

**9076 (for 2 ganged potentiometers)**

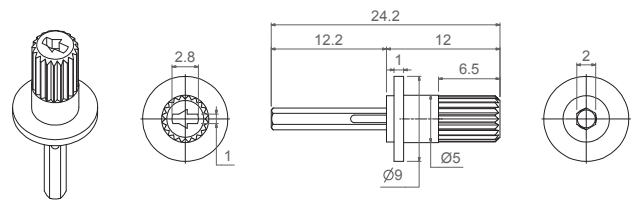

**Thumbwheel**

Thumbwheels are available in different colors (color chart in "how to order" section) and with self-extinguishable property according to UL 94 V-0, under request. Thumbwheels can be mounted on the potentiometers at ACP or sold separately. ACP can study special thumbwheel designs.

**9002**

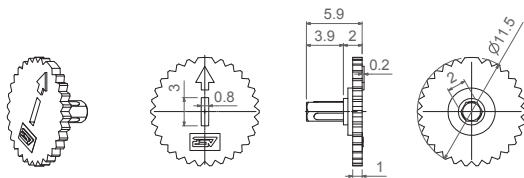

**9041**

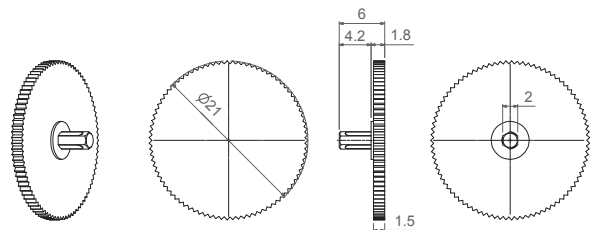

**9060 (Designed for R rotor)**

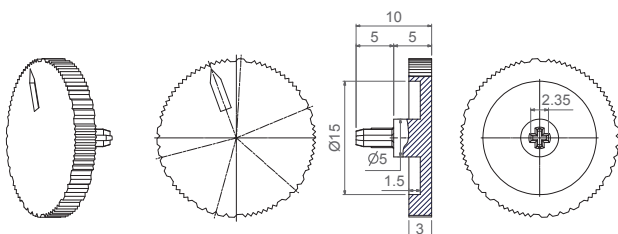

**9061**

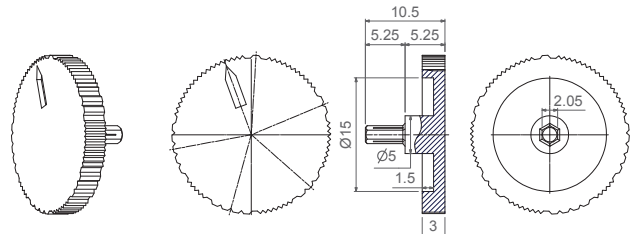

**Bulk packaging:**

Potentiometer model	With shaft or thumbwheel inserted?	Pieces per small box (150 x 100 x 70)	Pieces per bigger box (250 x 150 x 70, CG on description)
H2,5 - H3,8 - HS3,8 - H5 HSMD - V7,5 - V10 VK10 - VR10 - VSMD	None, only potentiometers.	500	1.500
	9002	250	1.000
	9004, 9005, 9006, 9009, 9010, 9018, 9039, 9041, 9047, 9048, 9051, 9053, 9054, 9055, 9056, 9059, 9060, 9061, 9063, 9064, 9067, 9070.	200	1.000 in general
	9071, 9072	400	1.250
KAV - MAV - MTV	None, only potentiometers.	400	1.250
MTX2	9048, 9074, 9076	150	To be determined.
MTX4	9039, 9051	75	To be determined.
MTX6	9018	50	To be determined.
MTX8	9056	40	To be determined.

**Tape & Reel packaging:**

	With thumbwheel inserted?	13" Reel (Standard), with 24mm width tape	15" Reel, with 24mm width tape
VSMD	None, only potentiometers.	900 pcs per reel, 12mm step between cavities.	1.250 pcs per reel, 12mm step between cavities.
	9002	700 pcs per reel, 12mm step between cavities.	To be determined.
VSMD...CY	None, only potentiometers.	750 pcs per reel, 12 mm step between cavities	1000 pcs per reel, 12 mm step between cavities
	9002	To be determined	To be determined
HSMD		350 pcs per reel, 16 mm step between cavities	475 pcs per reel, 16 mm step between cavities
H2,5...PIP TP25 - H5...PIP TP25 - HS3,8... PIP	None, only potentiometers or 9002	250	350
V7,5...PIP - V10...PIP - V10...PIP TP25 - VR10...PIP		250	400

The 13" reel is the standard. For the 15" reel, T&R15 is added to the description.

**VSMD-T&R**

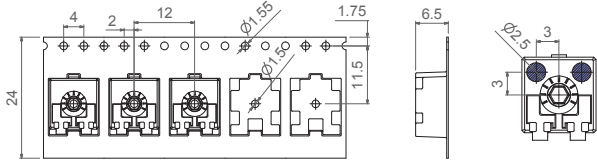

**VSMD-T&R...WT-9002**

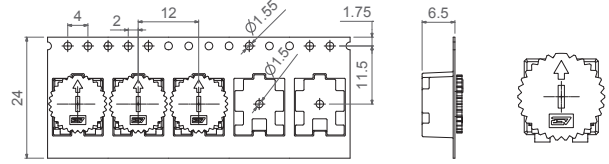

**VSMD-T&R ...CY**

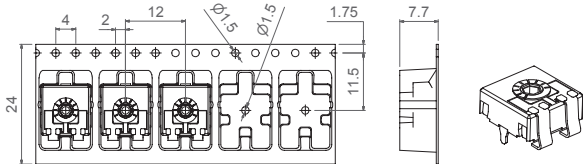

**VSMD-T&R...CY WT-9002**

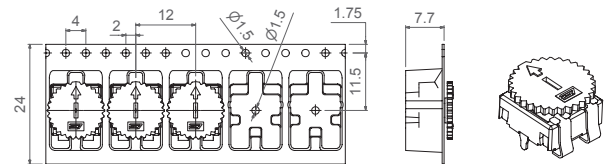

**HSMD-T&R**

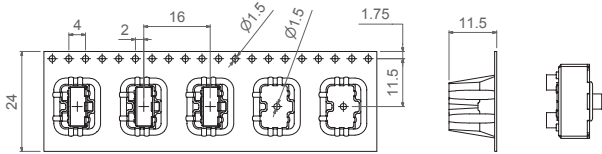

**13" Reel**

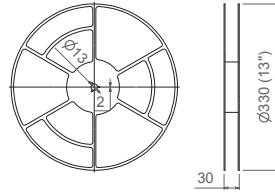

**15" Reel**

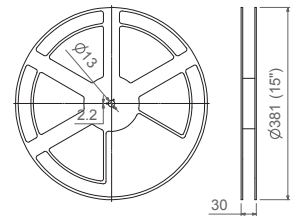

**V7,5-T&R...PIP**

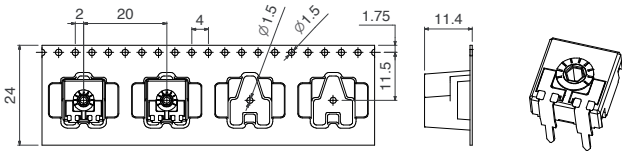

**V7,5-T&R... PIP WT-9002**

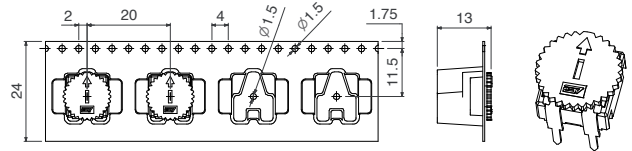

**V10-T&R... PIP**

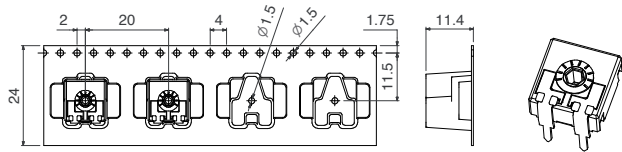

**V10-T&R...PIP WT-9002**

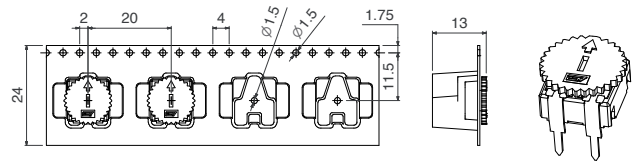

**V10-T&R...PIP TP25**

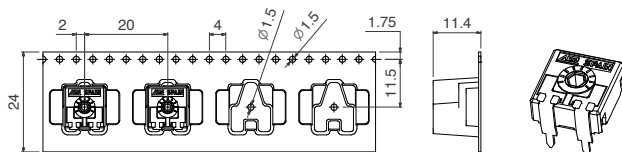

**V10-T&R...PIP TP25 WT-9002**

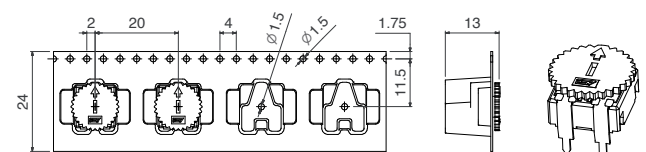

VR10-T&R...PIP

VR10-T&R... PIP WT-9002

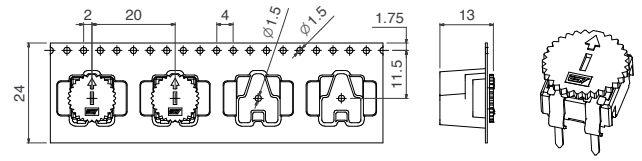
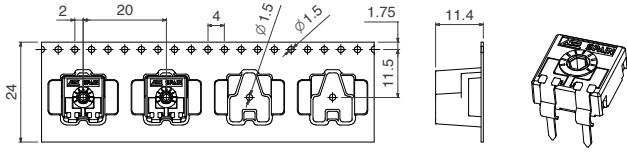

HS3,8-T&R... PIP

H5-T&R...PIP TP25

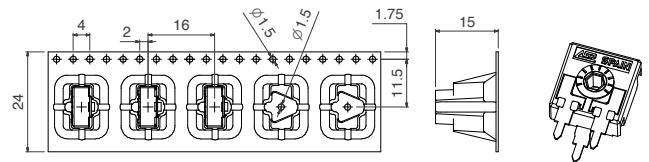
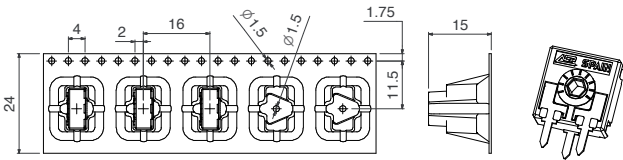

H2,5-T&R...PIP TP25

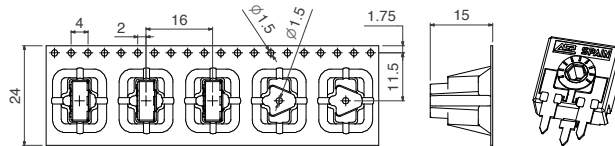

## Electric Specifications

These are standard features; other specifications and out of range values can be studied on request.

	CA9 Through-hole	CA9 SMD	CE9 Through-hole and SMD
Range of resistance values* Lin (A) Log (B) Antilog (C)	100Ω ≤ Rn ≤ 5MΩ 1 KΩ ≤ Rn ≤ 2M2Ω	100Ω ≤ Rn ≤ 1MΩ 1 KΩ ≤ Rn ≤ 1 MΩ	100Ω ≤ Rn ≤ 5MΩ 1 KΩ ≤ Rn ≤ 2M2Ω
Tolerance* Rn < 100Ω: 100Ω ≤ Rn ≤ 100KΩ 100K < Rn ≤ 1MΩ: 1MΩ < Rn ≤ 5MΩ: Rn > 5MΩ:	+50%, -30% (out of range) ±20% ±20% ±30% +50%, -30% (out of range)	- ±30% ±40% ±50% -	- ±20% ±20% ±30% -
Variation laws	Lin (A), Log (B), Antilog (C). Other tapers available on request		
Residual resistance	Lin (A), Log (B), Antilog (C) ≤ 5*10 <sup>-3</sup> *Rn. Minimum value 2Ω		≤2Ω
CRV - Contact Resistance Variation (dynamic)	Lin (A) Electrical Angle 220°±20° ≤ 3%Rn. Other tapers, please inquire		
CRV - Contact Resistance Variation (static)	Lin (A) Electrical Angle 220°±20° ≤ 5%Rn. Other tapers, please inquire		
Maximum power dissipation** Lin (A) Log (B), Antilog (C)	at 50°C 0.15W 0.10W		at 70° C. 0.5W 0.20W
Maximum voltage Lin (A) Log (B), Antilog (C)	200VDC 150VDC		200VDC
Operating temperature	-25°C ... +70°C (+85°C on request)		-40°C ... +90°C (+125°C on request)
Temperature coefficient 100Ω ≤ Rn ≤ 10KΩ 10KΩ < Rn ≤ 5MΩ	+200/ -300 ppm +200/ -500 ppm	+200/ -500 ppm +200/ -1000 ppm	±100 ppm ±100 ppm

\* Out of range ohm values and tolerances are available on request, please, inquire.

\*\* Dissipation of special tapers will vary, please, inquire.

## Mechanical Specifications

	CA9 Through-hole	CA9 SMD	CE9 Through-hole and SMD
Resistive element	Carbon technology	Carbon technology	Cermet
Angle of rotation (mechanical)	240° ± 5°		
Angle of rotation (electrical)	220° ± 20°		
Wiper standard delivery position	50% ± 15°		
Max. stop torque	5 Ncm		
Max. push/pull on rotor	40 N		
Wiper torque*	<2 Ncm Potentiometers with detents: <2.5 Ncm		
Mechanical life	1.000 cycles (many more available on request, please, inquire)		

\* Stronger or softer torque feeling is available on request.

## Test results

The following typical test results are given at 23°C ±2°C and 50% ±25% RH.

	CA9 Through-hole and SMD		CE9 Through-hole and SMD	
	Test conditions	Typical variation of nominal resistance	Test conditions	Typical variation of nominal resistance
Damp heat	500 h. at 40°C and 95% RH	+5%, -2%	500 h. at 40°C and 95% RH	±2%
Thermal cycles	16 h at 85°C, plus 2 h at -25°C	±2.5%	16 h at 90°C, plus 2 h at -40°C	±2%
Load life	1.000 h. at 50°C	+0%; -6%	1.000 h. at 70°C	±2%
Mechanical life	1.000 cycles at 10 c.p.m. and at 23°C ± 2°C	±3%	1.000 cycles at 10 c.p.m. and at 23°C ± 2°C	±3%
Storage (3 years)	3 years at 23°C ± 2°C	±3%	3 years at 23°C ± 2°C	±1%

CA9 Through-hole and SMD

CE9 Through-hole and SMD

Power derating curve:

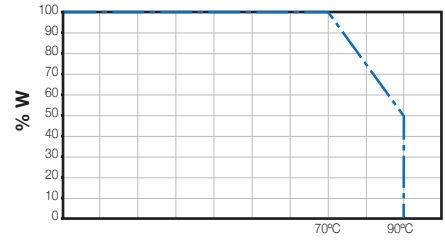
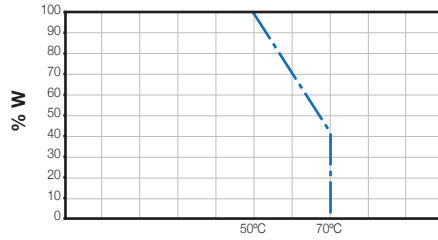

For temperatures out of range

The normal operation temperature for a carbon ACP potentiometer is -25°C to +70°C. When the temperature goes up to 85°C, the following variations should be observed:

Load life	1.000 h. at 50°C	+0%; -6%	1.000 h. at 85°C	+0%; -15%
-----------	------------------	----------	------------------	-----------

The power derating curve to consider is:

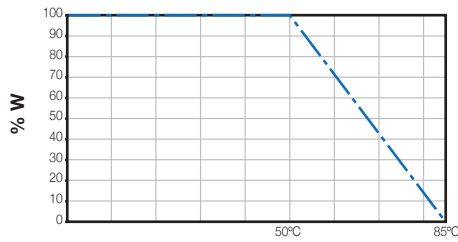

Representation of the typical variation of nominal resistance (with 95% confidence) throughout the ohm value range:

CA9 Through-hole and SMD

CE9 Through-hole and SMD

Damp heat

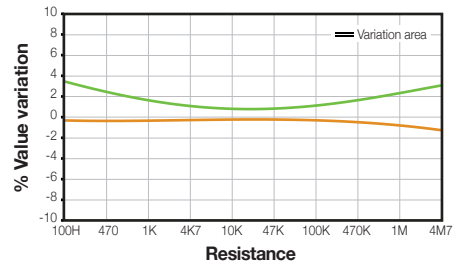
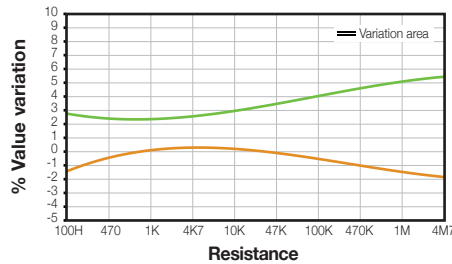

Temperature Coefficient

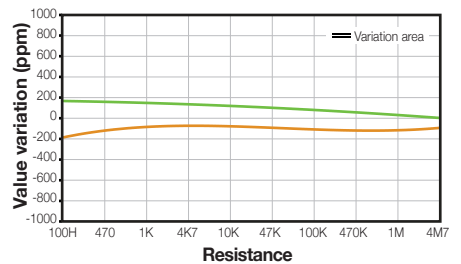
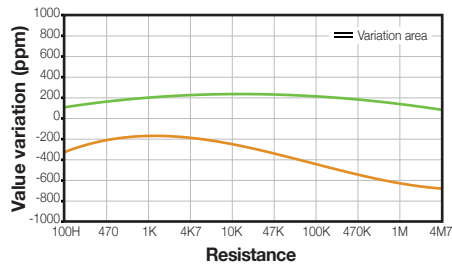

Load life

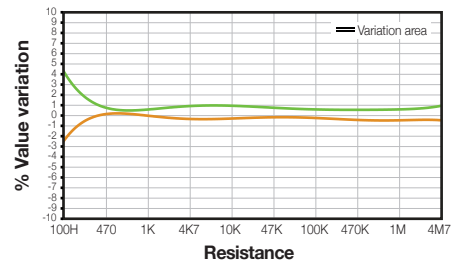
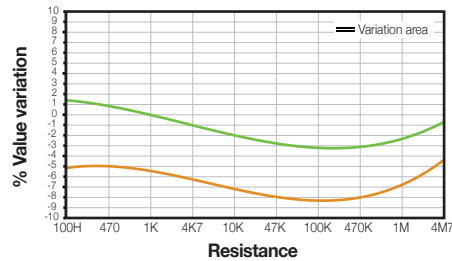

Mechanical life

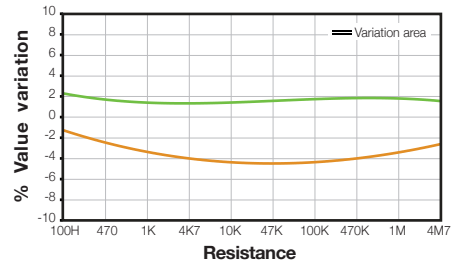
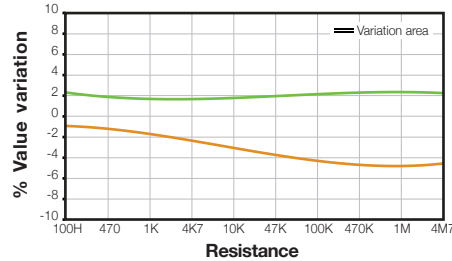

# CA14

Carbon Potentiometers CA

# CE14

Cermet Potentiometers CE

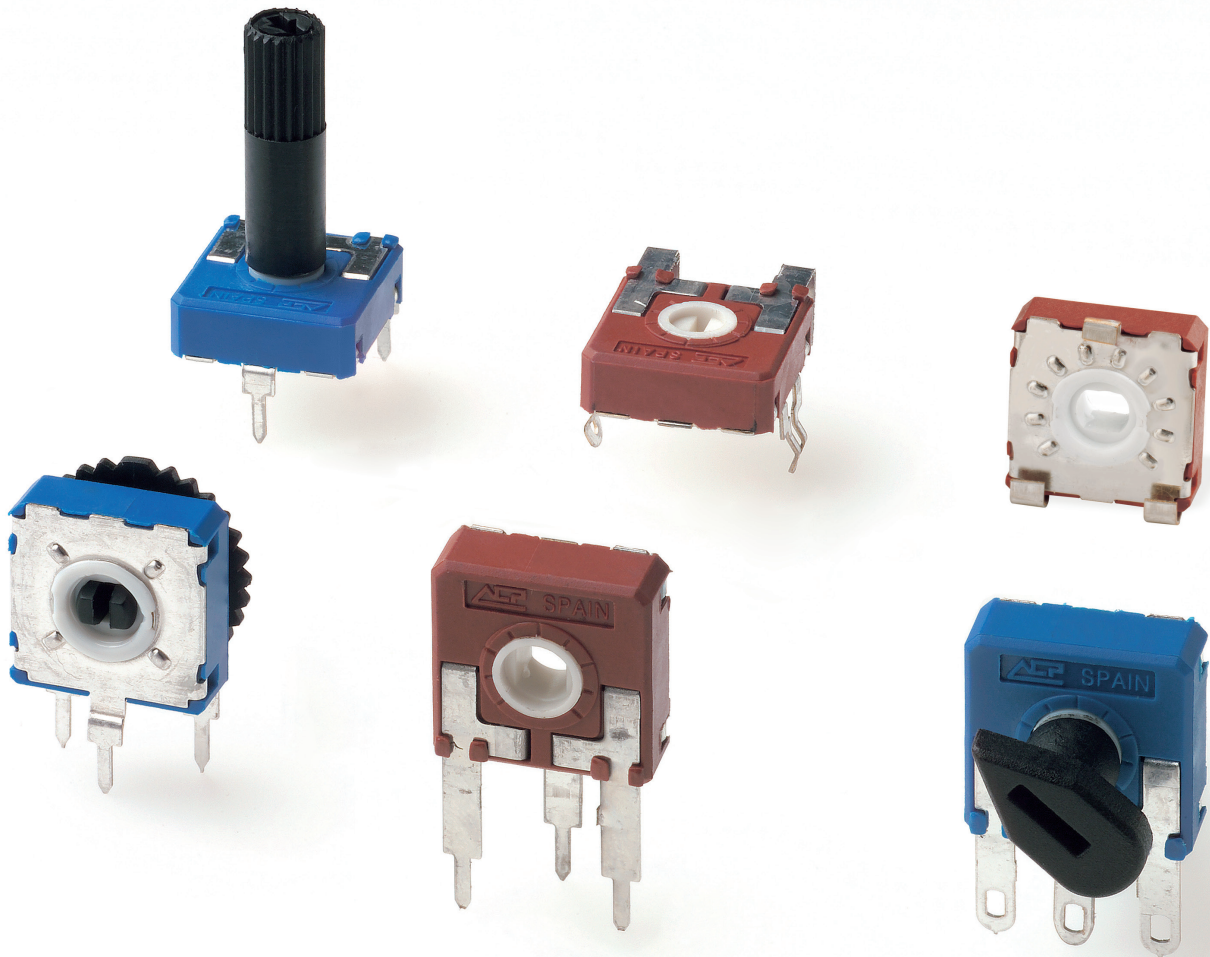

## CARBON – CA14

14mm carbon potentiometers with plastic housing and Ingress Protection rating type IP 54 (high level of protection against dust and also against water splashing), according to IEC 60529. Plastic materials can be self-extinguishable according to UL 94 V-0 under request.

Through-hole and SMD configurations are available. Terminals and collector are normally manufactured in tinned brass, although versions with steel terminals are also available under request. Terminals for through-hole models can be provided straight or crimped, which helps hold the component to the PCB during soldering.

Tapers can be linear, log and antilog; special tapers can also be studied.

ACP's potentiometers can be adjusted from either the front or the back, both in the horizontal and the vertical adjustment types. Thumbwheels and shafts can be ordered either separately or already inserted in the potentiometer.

Potentiometers can be manufactured in a wide range of possibilities regarding:

- Resistance value.
- Tolerance.
- Tapers / variation laws.
- Pitch.
- Positioning of the wiper (standard is at 50% rotation).
- Housing and rotor color.
- Mechanical life.
- Click effect (up to 38 detents available).
- Self-extinguishable plastic parts according to UL 94 V-0.

### Applications

14mm potentiometers are mainly used in control applications in different markets:

- Electronic household appliances, heating, ventilation and air conditioning (HVAC) equipment, thermostats.
- Automotive: HVAC controls, lighting regulation (position adjustment and sensing), dimmers, seat heating controls.
- Industrial electronics: multimeters, oscilloscopes, time relays, measurement and test equipment.

## CERMET – CE14

14mm cermet potentiometers with plastic housing and Ingress Protection rating type IP 54 (high level of protection against dust and also against water splashing), according to IEC 60529. Plastic materials (housing and rotor) are self-extinguishable according to UL 94 V-0. ACP's cermet potentiometers have better thermal stability, allow for higher thermal dissipation and withstand higher temperatures than carbon potentiometers.

Through-hole and SMD configurations are available. Terminals and collector are manufactured in tinned brass, although versions with steel terminals are also available under request. Terminals for through-hole models can be provided straight or crimped, which helps hold the component to the PCB during soldering.

Tapers can be linear, log and antilog; special tapers can also be studied.

ACP's potentiometers can be adjusted from either the front or the back, both in the horizontal and the vertical adjustment types. Thumbwheels and shafts can be ordered either separately or already inserted in the potentiometer.

Potentiometers can be manufactured in a wide range of possibilities regarding:

- Resistance value.
- Tolerance.
- Tapers / variation laws.
- Pitch.
- Positioning of the wiper (the standard is at 50%).
- Housing and rotor color.
- Mechanical life.
- Click effect (up to 38 detents available).

### Applications

14mm cermet potentiometers are used in applications where either the operating temperature is high, or where the applications requires product with excellent ohmic value stability:

- Electronic appliances: boilers, water heaters.
- Automotive: climate controls, position sensors.
- Industrial electronics: multimeters, oscilloscopes, time relays, measurement and test equipment.



# CA14 CE14 HOW TO ORDER

EXAMPLE: **CA14NV12,5-10KA2020 10DT SNP PI WT-14117-BA**

EXAMPLE: **CE14NV12,5-10KA2020 10DT SNP PI WT-14117-BA-V0**

Standard features								Extra features							Assembled accessory			
Series	Rotor	Model	Packg.	Ohm value	Taper	Tol.	Life	Track	Detents	Snap in	Housing	Rotor	Wiper	Lin.	Assembly	Ref #	Color	Flam.
1	2	3	4	5	6	7	8	9	10	11	12	13	14	15	16			
CA14/CE14	N	H2,5		- 10K	A	2020		10DT	SNP				PI		WT	14117	-BA	-V0

Standard configuration:	CA14 Through-hole	CA14 SMD	CE14 Through-hole and SMD
Dimensions:		14mm	
Protection:		IP 54 (dust-proof) On request: Self-extinguishable, to meet UL 94 V-0	
Substrate:	Carbon technology	Carbon technology, special for high temperature	Cermet
Color:	Blue housing + white rotor	Brown housing + grey rotor	Brown housing + white rotor
Packaging:		Bulk	
Wiper position:		at 50% ±15°	
Terminals:		Straight, without crimping.	
Marking:		Resistive value marked on housing. Others on request.	

**Customized products:** A drawing is requested when ordering a customized product. Series, rotor, model and total resistive value are indicated before the code that includes all special specifications. Example: CA14PH2,5-10K CODE C00111.

## 1 - Series

■ CA14 ■ CE14

## 2 - Rotors

B D E F G K M N P T X Z

## 3 - Model and pitch

H0 H0C H2,5 H4 H5 HA5 HL5 V12,5 VA12,5 VL12,5  
VR12,5 V15 VJ15 (V15) ... CFF V17,5 VD7,5 VD11 VSMD VSMD ... CY  
HSMD (Under request, not readily available)

## 4 - Packaging

### Trough-hole

### SMD models

Bulk	(blank)... <sup>(1)</sup>	(blank)... <sup>(1)</sup>
T&R (Tape and 13" reel)	(N.A.) <sup>(2)</sup>	T&R
T&R (Tape and 15" reel)	(N.A.) <sup>(2)</sup>	T&R15

(1) If blank, bulk packaging is implied. (2) N.A., Not Applicable: Tape and Reel packaging is only available for SMD terminals.

## 5 - Resistance value

100Ω 200Ω 220Ω 250Ω 470Ω 500Ω 1KΩ 2KΩ ... 500KΩ 1MΩ 2MΩ 2M2Ω 4M7Ω 5MΩ  
100 200 220 250 470 500 1K 2K 500K 1M 2M 2M2 4M7 5M

Other resistive values available on request.

## 6 - Resistance law / taper

Lin - Linear	A
Log - Logarithmic	B
Antilog - Antilogarithmic	C
- Special tapers have codes assigned:	CODE YXXXXX

## 7 - Tolerance

±20%	±30%	+50%, -30%	±10%	±5%
2020	3030	5030	1010	0505

## 8 - Operating Life (Cycles)

Standard (1.000 cycles) (leave blank)  
Long life: LV + the number of cycles. ex: LV10 for 10.000 cycles. (others on request) LVXX: ex: LV10

## 9 - Cut Track - Open circuit.

Open circuit at beginning of track, fully CCW	PCI
Open circuit at end of track, fully CW	PCF

## 10 - Detents (DT)

One detent at the beginning	DTI
One detent at the end	DTF
X number of detents	XDT: 10DT

Special detents are available on request: If you need to assign a voltage value to each detent, please inquire.

## 11 - Terminals

SNAP IN P	SNP
SNAP IN R	SNR
Shorter tip of terminal, TPXX, where XX is tip length (under request)	TPXX, ex: TP30
Steel Terminals	SH

## 12 - Housing

**Color:** For colors other than standard: -See color chart below- CJ-color, ex., red: CJ-RO

## 13 - Rotor

**Color:** For colors other than standard: -See color chart below- RT-color; ex., blue: RT-AZ

## \* Self-extinguishable property, V0, for housing and rotor:

By default, carbon is non self-extinguishable, cermet is Self-extinguishable: (blank)  
For carbon: self-extinguishable property can be added. V0 means housing and rotor are V0. If only the housing needs to be V0, then CJ-V0. V0  
If only rotor: RT-V0 CJ-V0, RT-V0

## 14 - Wiper

<b>Wiper position</b> (Standard: 50% ± 15°)	(leave blank)
Initial or CCW	PI
Final or CW	PF
Others: following clock positions; at 3 hours: P3H	PXH, ex: P3H

<b>Wiper torque</b> (Standard: <2.5Ncm, for detents: <3.5)	(leave blank)
Low torque, < 1.5Ncm	PGB

## 15 - Linearity

Not controlled	(leave blank)
Independent linearity controlled & below x%, for example, 3%: LN3%	LNx%; ex: LN3%
Absolute linearity controlled & below x%	LAX%

Other features could be available on request, please, ask.

## 16 - Potentiometers with assembled accessories

Assembled from terminal side	WT
Assembled from collector side	WTI
Accessory Reference	-XXXXX
See list of shafts and thumbwheels available	Example: 14117
Color of shaft or thumbwheel	-YY Example, white: BA
Non self-extinguishable. Self-extinguishable according to standard	(leave blank)
UL 94 (-V0 in box 17 modifies only the accessory, please, note.)	-V0

## For ordering spare accessories:

Accessory reference - color- flammability. XXXX-YY-V0  
Ex. 14117-AZ-V0 is a blue self-extinguishable 14117 thumbwheel

## Color chart for rotor, housing and accessories

Black <sup>(1)</sup>	White	Neutral	Transp.	Red	Green	Yellow	Blue	Grey	Brown
NE	BA	IN	TA	RO	VE	AM	AZ	GS	MR

(1) black is not an option for housings.

## Rotors

Rotors are drawn in their standard positioning, 50% of rotation. Alternative delivery positioning can be requested. Accessories in this catalogue are designed for N, Z and T rotors, unless otherwise stated.

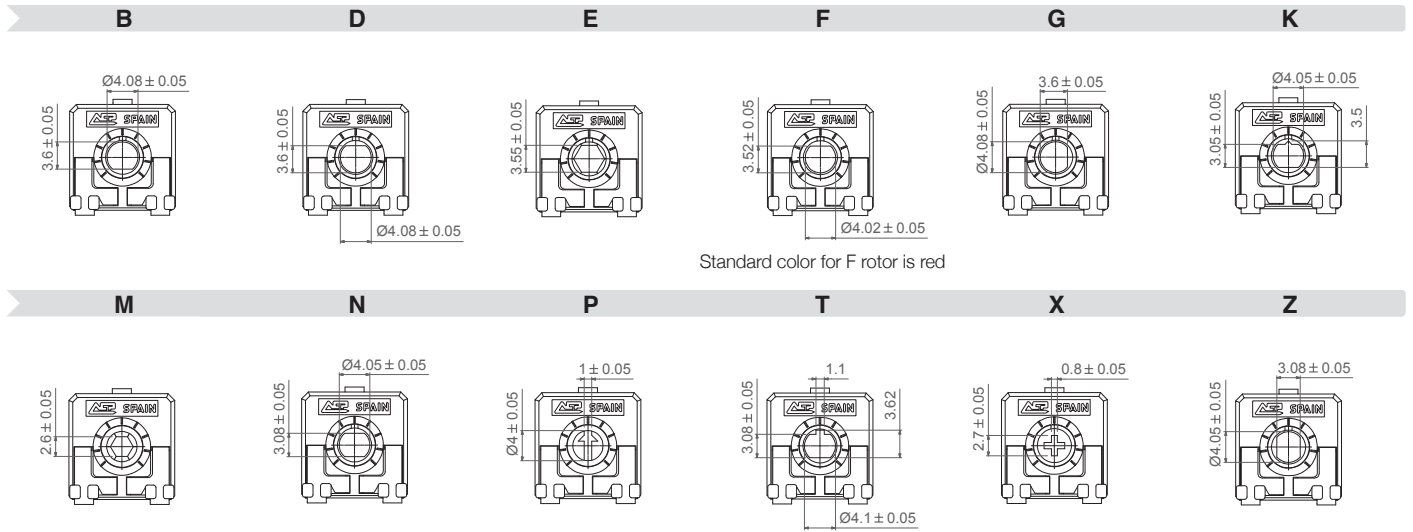

CA14 CE14

## Models

All models shown here have the most common rotor for 14mm potentiometers: the N rotor. Different rotors are available from the menu above.

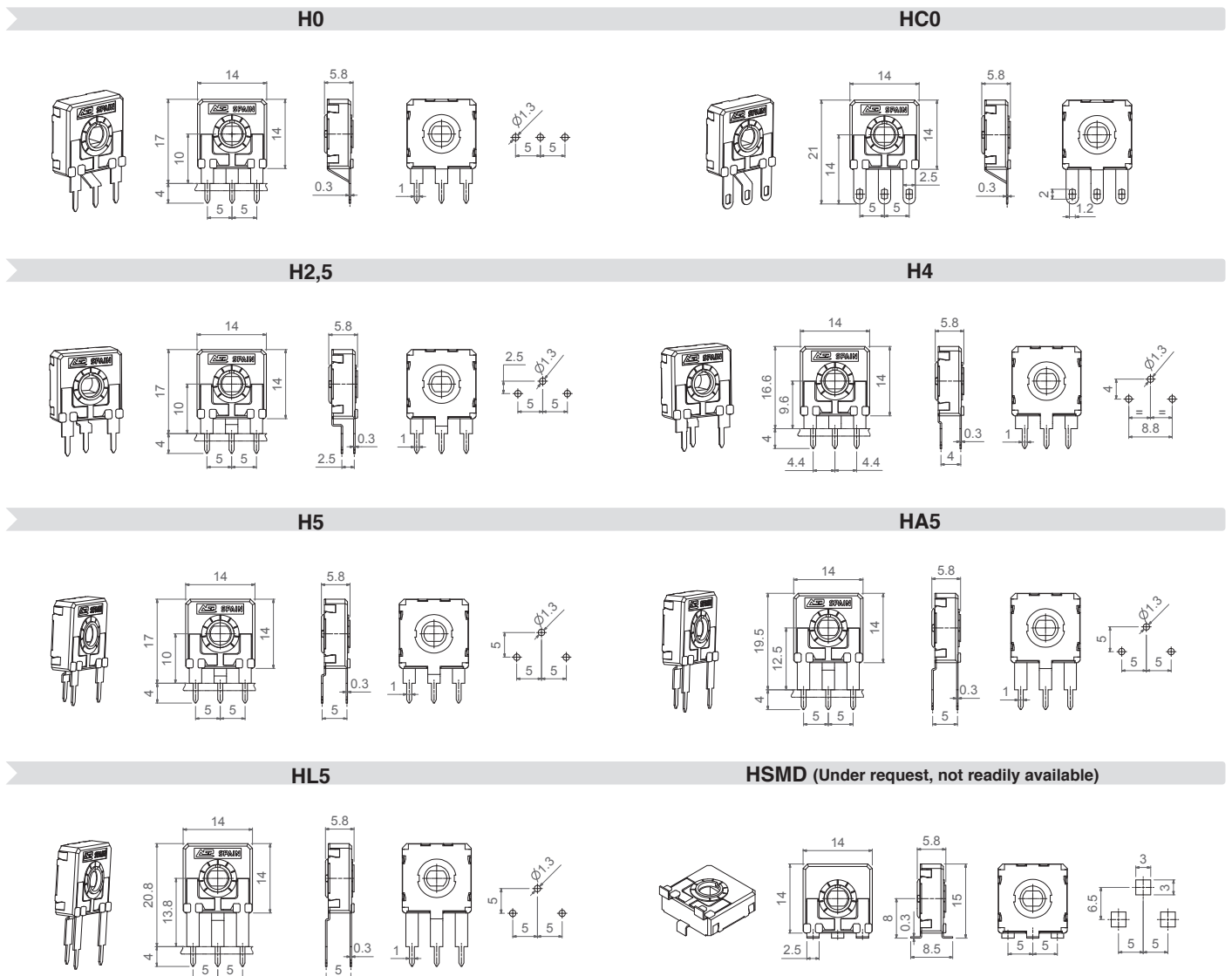

V12,5

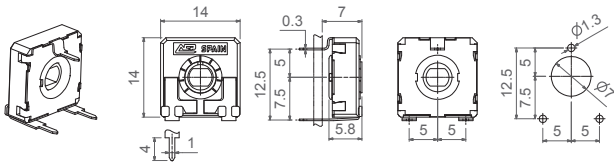

VA12,5

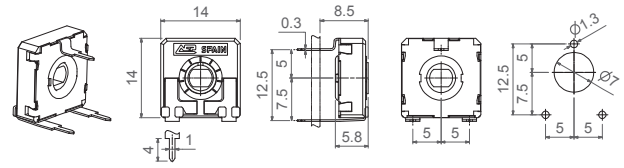

VL12,5

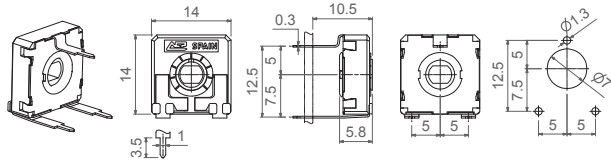

VR12,5

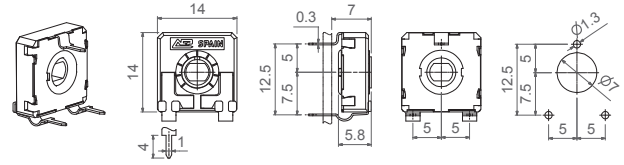

V15

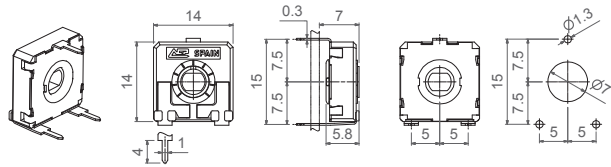

VJ15

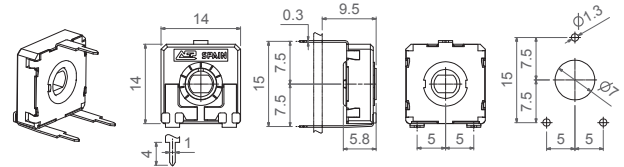

V15...CFF

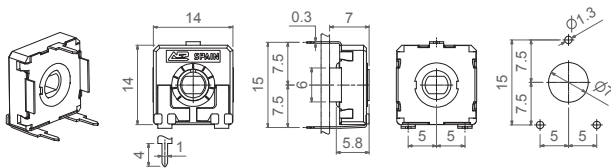

V17,5

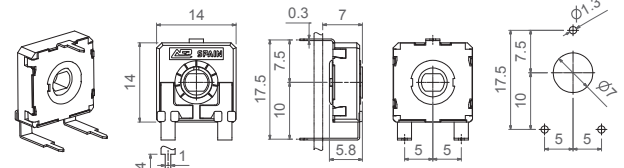

VD7,5

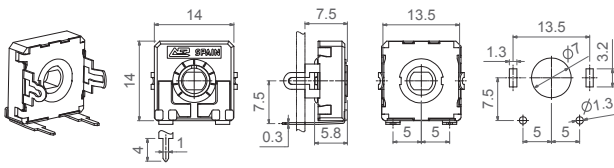

VD11

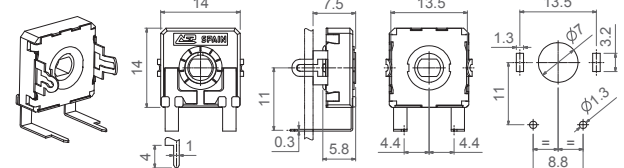

VSMD

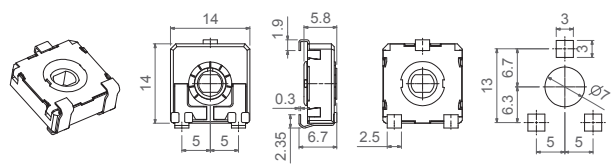

VSMD...CY

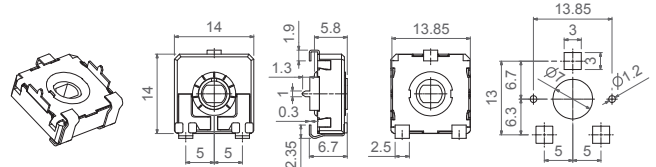

VSMD...CY WT-14003

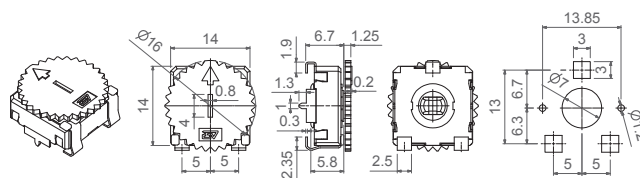

## Tapers

The standard taper is linear (A). Log (B) and Antilog (C) tapers are also available, as well as special tapers according to customer's specifications. For example, a special taper can be matched with a potentiometer with detents (click effect), to guarantee a value in a specific position – see “detents” section.-

### REGULAR TAPERS

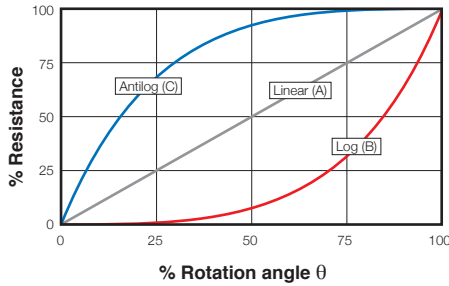

### SPECIAL TAPERS

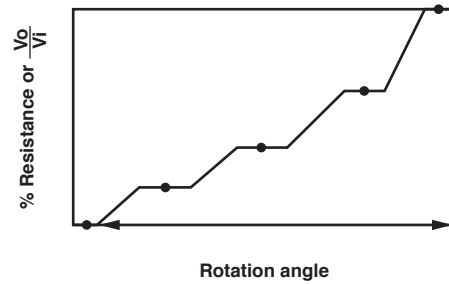

## Potentiometers with cut track

The cut track is an area with very high resistive value, resulting in an open circuit. It is widely used in lighting applications.

Mechanical life with cut track needs to be confirmed.

PCI = Cut at initial position, when the potentiometer is turned fully counter clockwise.

PCF = Cut at final position, when the potentiometer is turned fully clockwise.

Other positions are available on request.

### PCI

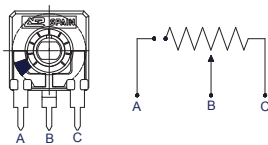

### PCF

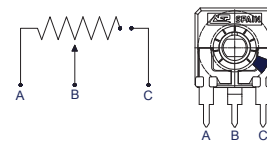

## Potentiometers with detents

ACP's patented detent (DT) feature is especially suitable for control applications where the end user will turn a knob inserted in the potentiometer. Detents can be used to add a click feeling to the turning of the potentiometer or to control the position in which the wiper is placed, assuring a particular output value with a narrow tolerance.

Detents can be light or strong, or even a combination of different feelings. They can be evenly distributed along the angle (standard) or tailored to match customers' request. They can also be combined with special tapers: constant value areas, open circuit zone, different slopes, etc. One common example is a potentiometer with detents and matching non-overlapping voltage values in specific angular positions used to feed in a voltage value to a microprocessor:

### Example of 5DT with control of value in each DT.

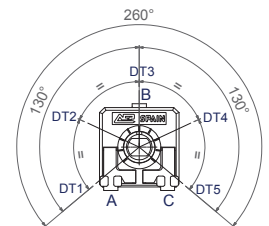
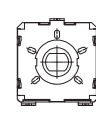
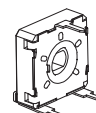
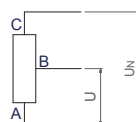
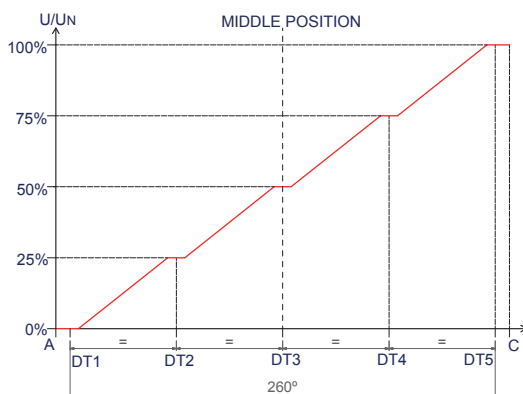

## Potentiometers with detents

Examples of some potentiometers with detents:

### 14DT

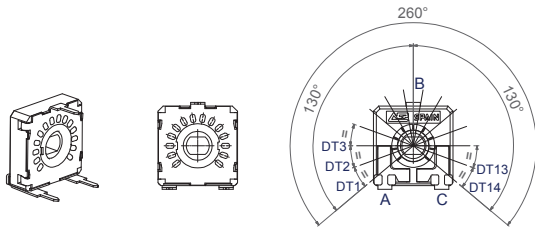

### 38DT

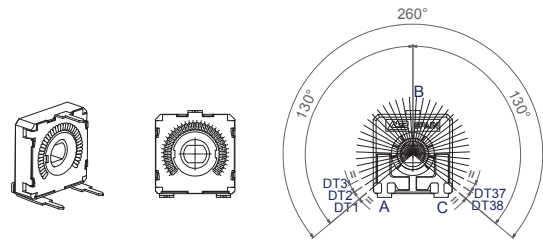

<b>Number of standard detents (evenly distributed) already available.</b> <b>Other configurations are available under request.</b>	1 (Initial, final or central), 3, 4, 5, 6, 7, 8, 9, 10, 13, 14, 17, 22, 27, 38.
<b>Maximum number of detents for feeling only</b>	38
<b>Maximum number of detents when the voltage value in each detent is controlled and non-overlapping.</b>	14

Our patented design with two wipers has improved the performance of these potentiometers, giving them more stable electrical parameters, improved reliability and Contact Resistance Variation (CRV) and narrower tolerances for detent positioning.

For potentiometers with detents, mechanical life is also 1.000 cycles, if no additional cycles are mentioned. Up to 10.000 cycles are available. Please, indicate the number of cycles needed with LV (number of cycles), for example: LV10, for 10.000 cycles.

## Terminals

By default, terminals are always straight, as shown on the "models" section. ACP can provide crimped terminals (with snap in, "SNP" or "SNR") to better hold the component to the PCB during the soldering operation.

### SNP

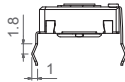

### SNR

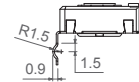

Also, there is an option of having shorter terminal tips:

### Standard Terminal

### Shorter terminal, for V12,5

### Shorter terminal, TPXX (under request)

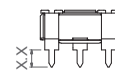
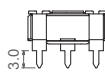
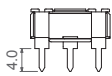

## Possibilities for insertion of accessories

Accessories can be mounted on potentiometers through either the front side (WT) or the collector side (WTI). For the specific angular position of shafts with planes, a drawing with the exact position is requested.

### WT Front side

### WTI Collector side

### WT Front side

### WTI Collector side

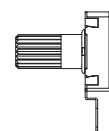
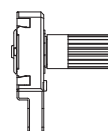

## Shafts

Shafts are available in different colors (color chart in “how to order” section) and with self-extinguishable property, according to UL 94 V-0, under request. ACP can study special shaft designs.

Shafts can be sold separately or delivered already mounted on the potentiometer at ACP.

When a shaft is mounted, the distance from the top of the potentiometer to the top of the shaft is marked with “L” in the table below, as shown in the drawings:

### H potentiometer + shaft

### V potentiometer + shaft

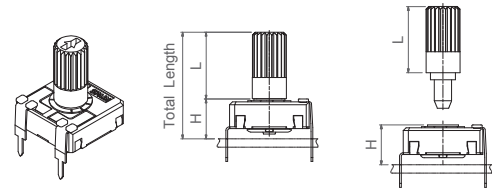
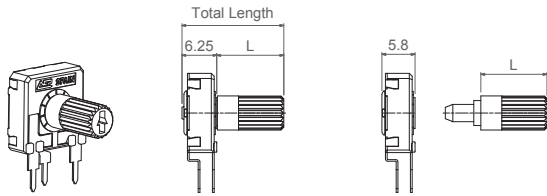

Shaft	14042	14065 (For E rotor)	14117	14056	14081	14187	14251	14067	14008	14015	14066	14084	14250	14072	14073
L Dimension	7.05	11.50	11.70	12.25	18.25	18.75	18.75	27.75	23.25	23.25	23.50	23.50	25.00	31.75	38.50

### 14008

### 14015

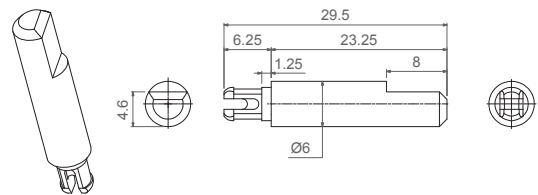
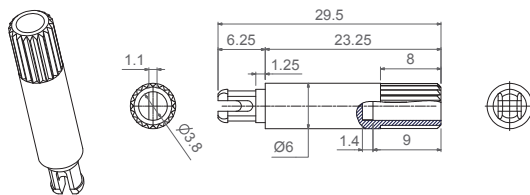

### 14042

### 14056

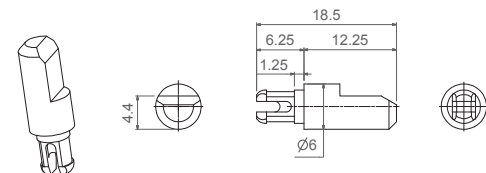
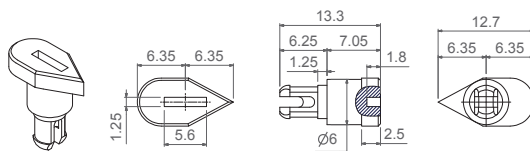

### 14065 (Designed for E rotor)

### 14066

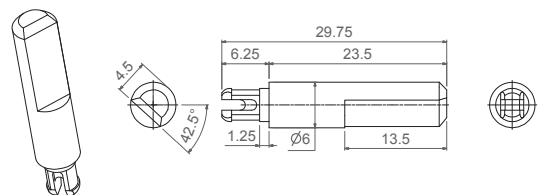
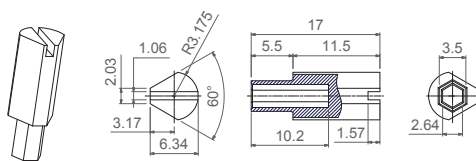

### 14067

### 14072

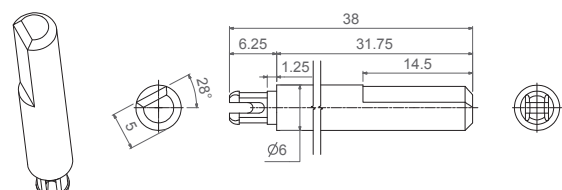
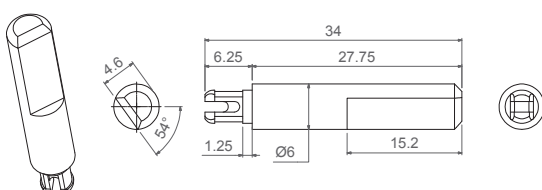

**14073**

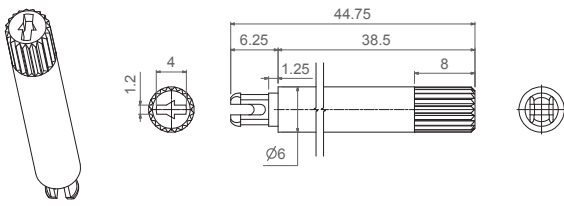

**14081**

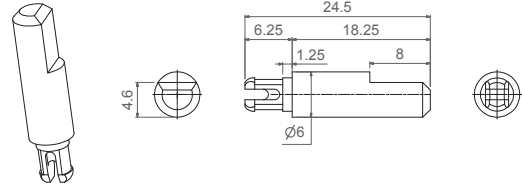

**14084**

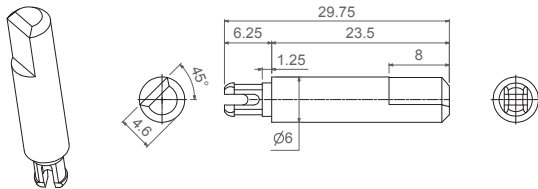

**14117**

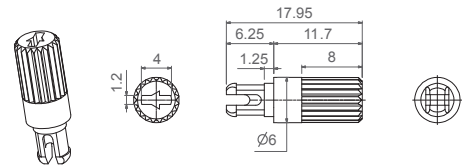

**14187**

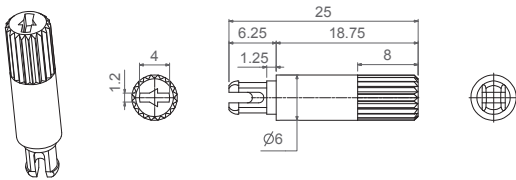

**14250**

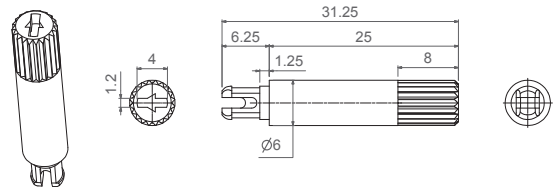

**14251**

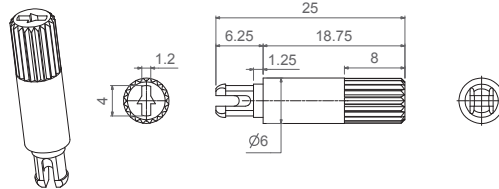

Thumbwheels are available in different colors (color chart in "how to order" section) and with self-extinguishable property according to UL 94 V-0, under request. Thumbwheels can be mounted on the potentiometers at ACP or sold separately. ACP can study special thumbwheel designs.

**14003**

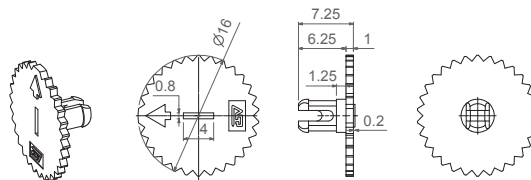

**Bulk packaging:**

Potentiometer model	With shaft or thumbwheel inserted?	Pieces per small box (150 x 100 x 70)	Pieces per bigger box (250 x 150 x 70, CG on description)
H2,5 - H4 - H5- HA5- HL5- H0 HC0 - V12,5 - V15 - VA12,5 VL12,5 - VJ15 - V17,5* VD11* - VD7,5* - VR12,5	None, only potentiometers.	200 150 for models with*	700 600 for VJ15 - V17,5 - VD7,5 500 for VD11
	14003, 14117, 14042, 14056, 14065	100	400 350 for models with*
	14008, 14015, 14066, 14067, 14072, 14073, 14081, 14084, 14187, 14250.	75	To be determined.

For models with \* and an inserted accessory, please, inquire about the quantity per box in that case.  
Optional box 140x140x70 is available on request.

**Tape & Reel packaging:**

	With thumbwheel inserted?	13" Reel (Standard), with 24mm width tape	15" Reel, with 24mm width tape
VSMD	None, only potentiometers.	500 pcs per reel, 16mm step between cavities.	800 pcs per reel, 16mm step between cavities.
	14003	450 pcs per reel, 16mm step between cavities.	To be determined.
VSMD... CY	None, only potentiometers.	350 pcs per reel, 20mm step between cavities.	500 pcs per reel, 20mm step between cavities.
	14003	350 pcs per reel, 20mm step between cavities.	To be determined.
HSMD		To be determined	To be determined.

The 13" reel is the standard. For the 15" reel, T&R15 is added to the description.

**VSMD-T&R**

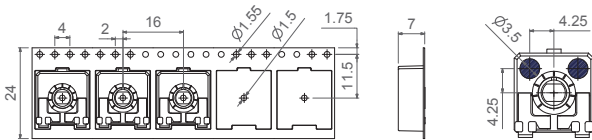

**VSMD-T&R...WT-14003**

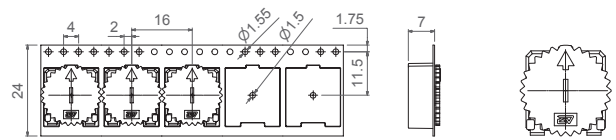

**VSMD-T&R ... CY**

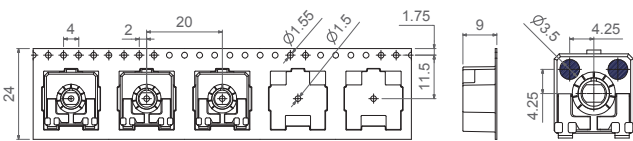

**VSMD-T&R...CY WT-14003**

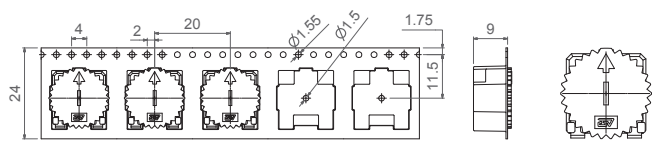

**13" Reel**

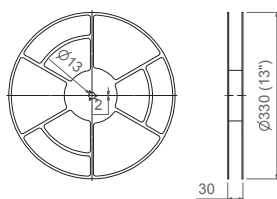

**15" Reel**

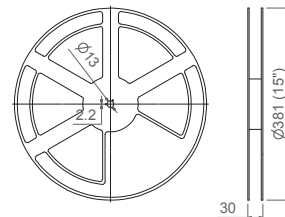



## Electric Specifications

These are standard features; other specifications and out of range values can be studied on request.

	CA14 Through-hole	CA14 SMD	CE14 Through-hole and SMD
Range of resistance values* Lin (A) Log (B) Antilog (C)	100Ω ≤ Rn ≤ 5MΩ 1 KΩ ≤ Rn ≤ 2M2Ω	100Ω ≤ Rn ≤ 1MΩ 1 KΩ ≤ Rn ≤ 1 MΩ	100Ω ≤ Rn ≤ 5MΩ 1 KΩ ≤ Rn ≤ 2M2Ω
Tolerance* Rn < 100Ω: 100Ω ≤ Rn ≤ 100KΩ 100K < Rn ≤ 1MΩ: 1MΩ < Rn ≤ 5MΩ: Rn > 5MΩ:	+50%, -30% (out of range) ±20% ±20% ±30% +50%, -30% (out of range)	- ±30% ±40% ±50% -	- ±20% ±20% ±30% -
Variation laws	Lin (A), Log (B), Antilog (C). Other tapers available on request		
Residual resistance	Lin (A), Log (B), Antilog (C) ≤ 5*10 <sup>-3</sup> *Rn. Minimum value 2Ω		≤2Ω
CRV - Contact Resistance Variation (dynamic)	Lin (A) Electrical Angle 245°±20° ≤ 3%Rn. Other tapers, please inquire		
CRV - Contact Resistance Variation (static)	Lin (A) Electrical Angle 245°±20° ≤ 5%Rn. Other tapers, please inquire		
Maximum power dissipation** Lin (A) Log (B), Antilog (C)	at 50°C 0.25W 0.13W		at 70° C. 0.7W 0.30W
Maximum voltage Lin (A) Log (B), Antilog (C)	250VDC 200VDC		
Operating temperature	-25°C ... +70°C (+85°C on request)		-40°C ... +90°C (+125°C on request)
Temperature coefficient 100Ω ≤ Rn ≤ 10KΩ 10KΩ < Rn ≤ 5MΩ	+200/ -300 ppm +200/ -500 ppm	+200/ -500 ppm +200/ -1000 ppm	±100 ppm ±100 ppm

\* Out of range ohm values and tolerances are available on request, please, inquire.

\*\* Dissipation of special tapers will vary, please, inquire.

## Mechanical Specifications

	CA14 Through-hole	CA14 SMD	CE14 Through-hole and SMD
Resistive element	Carbon technology	Carbon technology	Cermet
Angle of rotation (mechanical)	265° ± 5°		
Angle of rotation (electrical)	245° ± 20°		
Wiper standard delivery position	50% ± 15°		
Max. stop torque	10 Ncm		
Max. push/pull on rotor	50 N		
Wiper torque*	<2.5 Ncm Potentiometers with detents: <3.5 Ncm		
Mechanical life	1.000 cycles (many more available on request, please, inquire)		

\* Stronger or softer torque feeling is available on request.

## Test results

The following typical test results (with 95% confidence) are given at 23°C ±2°C and 50% ±25% RH.

	CA14 Through-hole and SMD		CE14 Through-hole and SMD	
	Test conditions	Typical variation of Rn	Test conditions	Typical variation of Rn
Damp heat	500 h. at 40°C and 95% RH	+5%, -2%	500 h. at 40°C and 95% RH	±2%
Thermal cycles	16 h at 85°C, plus 2 h at -25°C	±2.5%	16 h at 90°C, plus 2 h at -40°C	±2%
Load life	1.000 h. at 50°C	+0%; -5%	1.000 h. at 70°C	±2%
Mechanical life	1.000 cycles at 10 c.p.m. and at 23°C ± 2°C	±3%	1.000 cycles at 10 c.p.m. and at 23°C ± 2°C	±2%
Storage (3 years)	3 years at 23°C ± 2°C	±3%	3 years at 23°C ± 2°C	±1%

CA14 Through-hole and SMD

CE14 Through-hole and SMD

Power derating curve:

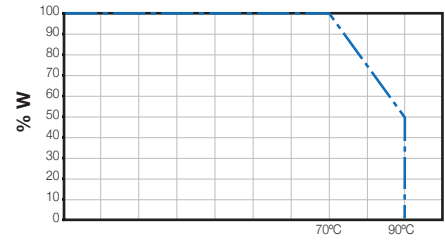
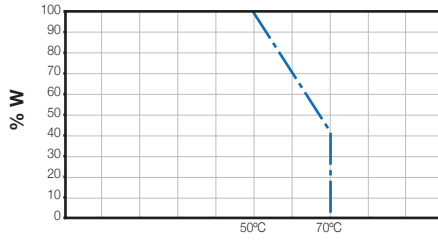

For temperatures out of range

The normal operation temperature for a carbon ACP potentiometer is -25°C to +70°C. When the temperature goes up to 85°C, the following variations should be observed:

Load life	1.000 h. at 50°C	+0%; -6%	1.000 h. at 85°C	+0%; -15%
-----------	------------------	----------	------------------	-----------

The power derating curve to consider is:

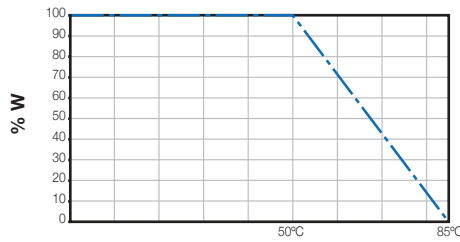

Representation of the typical variation of nominal resistance (with 95% confidence) throughout the ohm value range:

CA14 Through-hole and SMD

CE14 Through-hole and SMD

Damp heat

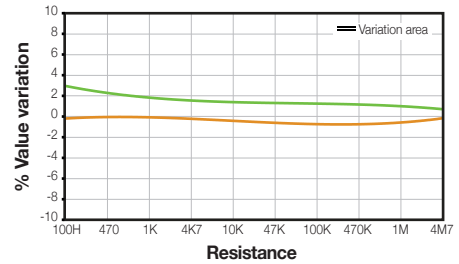
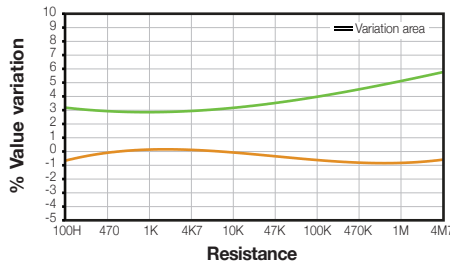

Temperature Coefficient

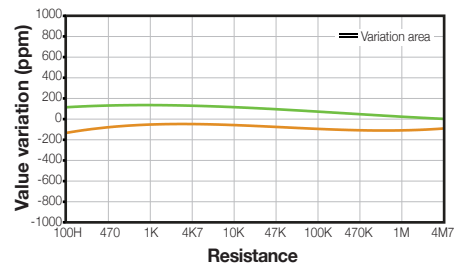
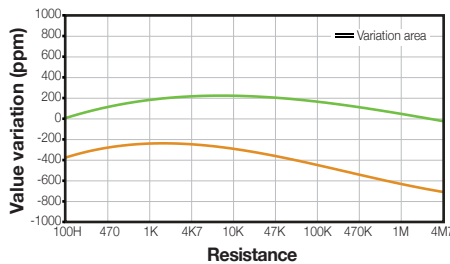

Load life

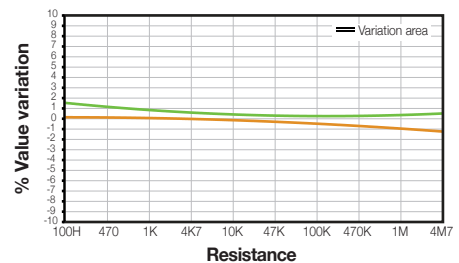
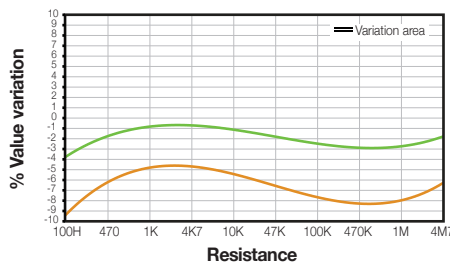

Mechanical life

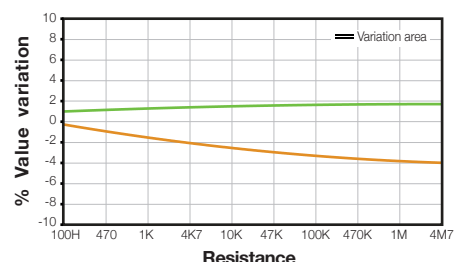
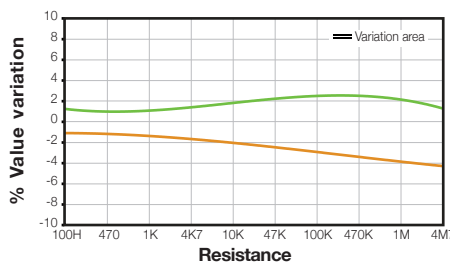

## CAR14

Carbon Potentiometers CAR

## CER14

Cermet Potentiometers CER

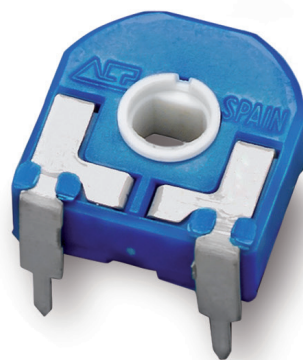
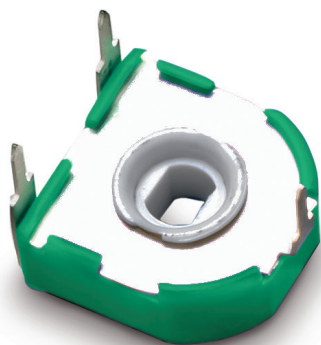

## CARBON – CAR 14

This product family **was** born as an alternative to the CA14 series when curved designs appear. Housing shape has been modified in order to set the product properly.

CAR14, carbon potentiometers with plastic housing and Ingress Protection rating type IP 54 (high level of protection against dust and also against water splashing), according to IEC 60529. Plastic materials can be self-extinguishable according to UL 94 V-0 under request.

Through-hole configuration is available; for SMD version, please, inquire. Terminals and collector are normally manufactured in tinned brass, although versions with steel terminals are also available under request. Terminals for through-hole models can be provided straight or crimped, which helps hold the component to the PCB during soldering.

Tapers can be linear, log and antilog; special tapers can also be studied.

Potentiometers can be manufactured in a wide range of possibilities regarding:

- Resistance value.
- Tolerance.
- Tapers / variation laws.
- Pitch.
- Positioning of the wiper (standard is at 50% rotation).
- Housing and rotor color.
- Mechanical life.
- Self-extinguishable plastic parts according to UL 94 V-0.

### Applications

CAR14 is mainly used in control applications in different markets:

- Electronic household appliances, heating, ventilation and air conditioning (HVAC) equipment, thermostats.
- Automotive: HVAC controls, lighting regulation (position adjustment and sensing), dimmers, seat heating controls.
- Industrial electronics: multimeters, oscilloscopes, time relays, measurement and test equipment.

## CERMET – CER14

This product family **was** born as an alternative to the CA14 series when curved designs appear. Housing shape has been modified in order to set the product properly.

CER14, cermet potentiometers with plastic housing and Ingress Protection rating type IP 54 (high level of protection against dust and also against water splashing), according to IEC 60529. Plastic materials (housing and rotor) are self-extinguishable according to UL 94 V-0. ACP's cermet potentiometers have better thermal stability, allow for higher thermal dissipation and withstand higher temperatures than carbon potentiometers.

Through-hole configuration is available; for SMD version, please, inquire. Terminals and collector are normally manufactured in tinned brass, although versions with steel terminals are also available under request. Terminals for through-hole models can be provided straight or crimped, which helps hold the component to the PCB during soldering.

Tapers can be linear, log and antilog; special tapers can also be studied.

Potentiometers can be manufactured in a wide range of possibilities regarding:

- Resistance value.
- Tolerance.
- Tapers / variation laws.
- Pitch.
- Positioning of the wiper (standard is at 50% rotation).
- Housing and rotor color.
- Mechanical life.

### Applications

CER14 is used in applications where either the operating temperature is high, or where the applications requires product with excellent ohmic value stability:

- Electronic appliances: boilers, water heaters.
- Automotive: climate controls, position sensors.
- Industrial electronics: multimeters, oscilloscopes, time relays, measurement and test equipment.

# CAR14 CER14 HOW TO ORDER

EXAMPLE: **CAR14NV12,5-10KA2020 10DT SNP PI WT-14117-BA**

EXAMPLE: **CER14NV12,5-10KA2020 10DT SNP PI WT-14117-BA-V0**

Standard features								Extra features							Assembled accessory			
Series	Rotor	Model	Packg.	Ohm value	Taper	Tol.	Life	Track	Detents	Snap in	Housing	Rotor	Wiper	Lin.	Assembly	Ref #	Color	Flam.
1	2	3	4	5	6	7	8	9	10	11	12	13	14	15	16			
CAR14/CER14	N	H2,5		- 10K	A	2020		10DT	SNP				PI		WT	14117	-BA	-V0

Standard configuration:	CAR14 Through-hole	CER14 Through-hole
Dimensions:	14mm	
Protection:	IP 54 (dust-proof) On request: Self-extinguishable, to meet UL 94 V-0	
Substrate:	Carbon technology	Cermet
Color:	Blue housing + white rotor	Brown housing + white rotor
Packaging:	Bulk	
Wiper position:	at 50% ± 15°	
Terminals:	Straight, without crimping.	
Marking:	Resistive value marked on housing. Others on request.	

**Customized products:** A drawing is requested when ordering a customized product. Series, rotor, model and total resistive value are indicated before the code that includes all special specifications. Example: CAR14PH2,5-10K CODE C00111.

## 1 - Series

■ CAR14 ■ CER14

## 2 - Rotors

B D E F G K M N P T X Z

## 3 - Model and pitch

V15 VR15

## 4 - Packaging

### Trough-hole

Bulk (blank)...<sup>(1)</sup>

(1) If blank, bulk packaging is implied.

## 5 - Resistance value

100Ω 200Ω 220Ω 250Ω 470Ω 500Ω 1KΩ 2KΩ ... 500KΩ 1MΩ 2MΩ 2M2Ω 4M7Ω 5MΩ

100 200 220 250 470 500 1K 2K 500K 1M 2M 2M2 4M7 5M

Other resistive values available on request.

## 6 - Resistance law / taper

Lin - Linear A

Log - Logarithmic B

Antilog - Antilogarithmic C

- Special tapers have codes assigned: CODE YXXXXX

## 7 - Tolerance

±20% ±30% +50%,-30% ±10% ±5%

2020 3030 5030 1010 0505

## 8 - Operating Life (Cycles)

Standard (1.000 cycles) (leave blank)

Long life: LV + the number of cycles. ex: LV10 for 10.000 cycles. (others on request) LVXX: ex: LV10

## 9 - Cut Track – Open circuit.

Open circuit at beginning of track, fully CCW PCI

Open circuit at end of track, fully CW PCF

## 10 - Detents (DT)

One detent at the beginning DTI

One detent at the end DTF

X number of detents XDT: 10DT

For this product: Only available under request

## 11 - Terminals

SNAP IN P SNP

Shorter tip of terminal, TPXX, where XX is tip length (under request) TPXX, ex: TP30

Steel Terminals SH

## 12 - Housing

Color: For colors other than standard: -See color chart below- CJ-color, ex., red: CJ-RO

## 13 - Rotor

Color: For colors other than standard: -See color chart below- RT-color; ex., blue: RT-AZ

### \* Self-extinguishable property, V0, for housing and rotor:

By default, carbon is non self-extinguishable, cermet is Self-extinguishable: (blank)  
For carbon: self-extinguishable property can be added. V0 means housing V0  
and rotor are V0. If only the housing needs to be V0, then CJ-V0. CJ-V0, RT-V0  
If only rotor: RT-V0

## 14 - Wiper

Wiper position (Standard: 50% ± 15°) (leave blank)

Initial or CCW PI

Final or CW PF

Others: following clock positions; at 3 hours: P3H PXH, ex: P3H

Wiper torque (Standard: <2.5Ncm, for detents: <3.5) (leave blank)

Low torque, < 1.5Ncm PGB

## 15 - Linearity

Not controlled (leave blank)

Independent linearity controlled & below x%, for example, 3%: LN3% LNx%; ex: LN3%

Absolute linearity controlled & below x% LAx%

Other features could be available on request, please, ask.

## 16 - Potentiometers with assembled accessories

Assembled from terminal side WT

Assembled from collector side WTI

Accessory Reference -XXXXX

See list of shafts and thumbwheels available Example: 14117

Color of shaft or thumbwheel -YY Example, white: BA

Non self-extinguishable, Self-extinguishable according to standard (leave blank)

UL 94 (-V0 in box 17 modifies only the accessory, please, note.) -V0

### For ordering spare accessories:

Accessory reference - color- flammability. XXXX-YY-V0

Ex. 14117-AZ-V0 is a blue self-extinguishable 14117 thumbwheel

### Color chart for rotor, housing and accessories

Black <sup>(1)</sup>	White	Neutral	Transp.	Red	Green	Yellow	Blue	Grey	Brown
NE	BA	IN	TA	RO	VE	AM	AZ	GS	MR

(1) black is not an option for housings.

## Rotors

Rotors are drawn in their standard positioning, 50% of rotation. Alternative delivery positioning can be requested. Accessories in this catalogue are designed for N, Z and T rotors, unless otherwise stated.

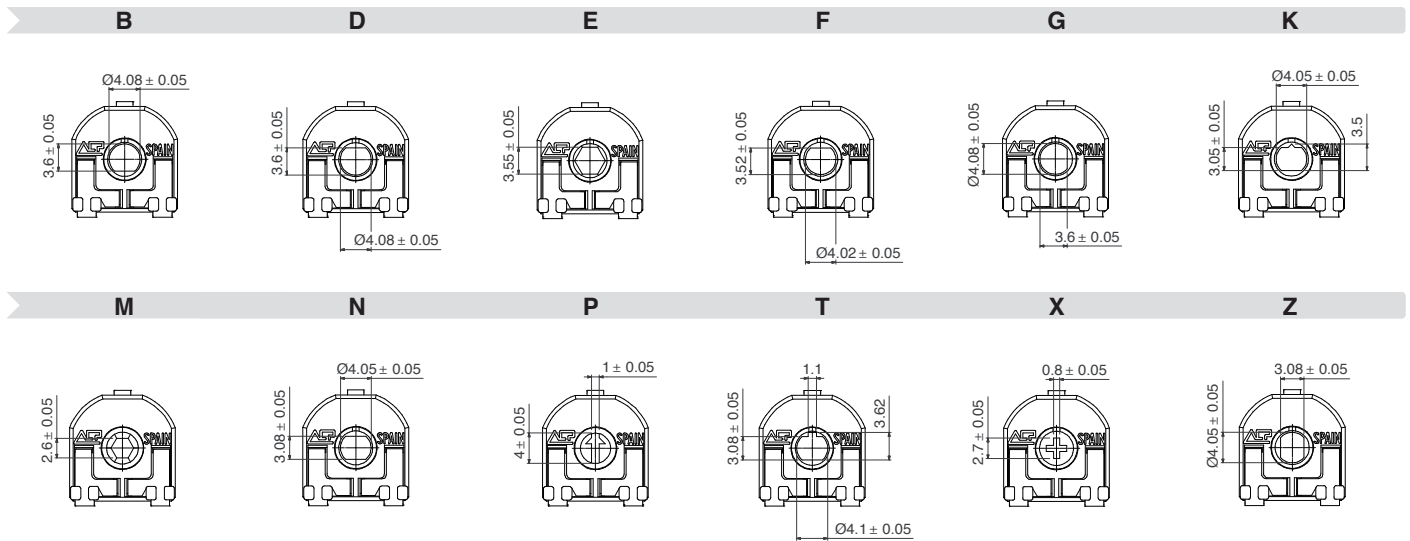

## Models

All models shown here have the most common rotor for 14mm potentiometers: the N rotor. Different rotors are available from the menu above.

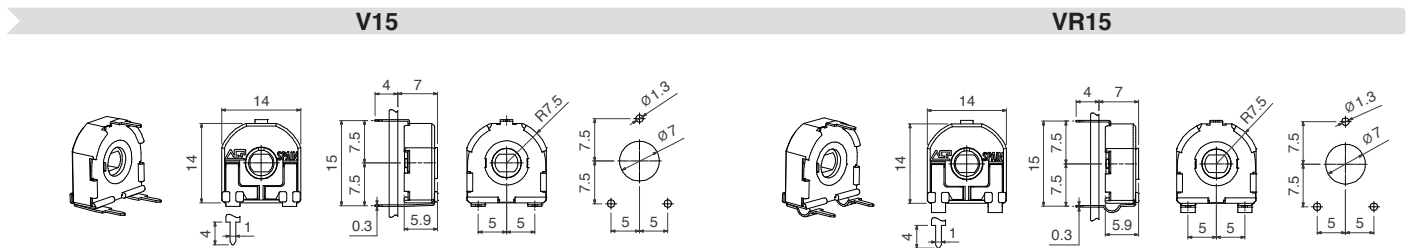

## Tapers

The standard taper is linear (A). Log (B) and Antilog (C) tapers are also available, as well as special tapers according to customer's specifications. For example, a special taper can be matched with a potentiometer with detents (click effect), to guarantee a value in a specific position – see "detents" section.-

### REGULAR TAPERS

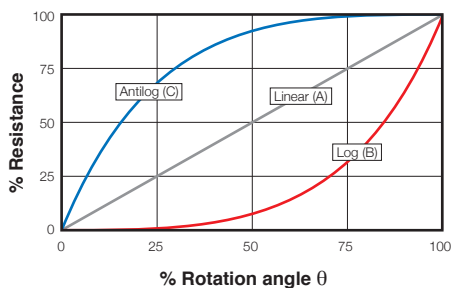

### SPECIAL TAPERS

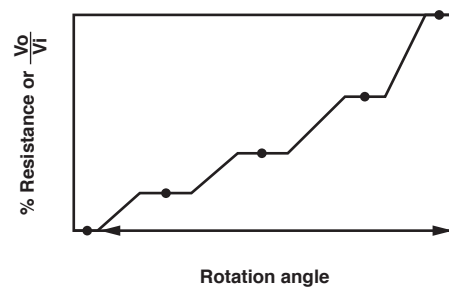

## Potentiometers with cut track

The cut track is an area with very high resistive value, resulting in an open circuit. It is widely used in lighting applications. Mechanical life with cut track needs to be confirmed.  
 PCI = Cut at initial position, when the potentiometer is turned fully counter clockwise.  
 PCF = Cut at final position, when the potentiometer is turned fully clockwise.  
 Other positions are available on request.

### PCI

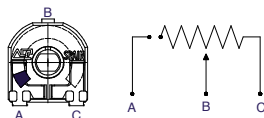

### PCF

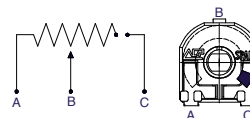

## Potentiometers with detents

ACP's patented detent (DT) feature is especially suitable for control applications where the end user will turn a knob inserted in the potentiometer. Detents can be used to add a click feeling to the turning of the potentiometer or to control the position in which the wiper is placed, assuring a particular output value with a narrow tolerance.

Detents can be light or strong, or even a combination of different feelings. They can be evenly distributed along the angle (standard) or tailored to match customers' request. They can also be combined with special tapers: constant value areas, open circuit zone, different slopes, etc. One common example is a potentiometer with detents and matching non-overlapping voltage values in specific angular positions used to feed in a voltage value to a microprocessor:

### Example of 5T with control of value in each DT.

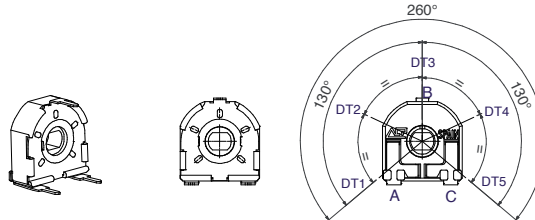
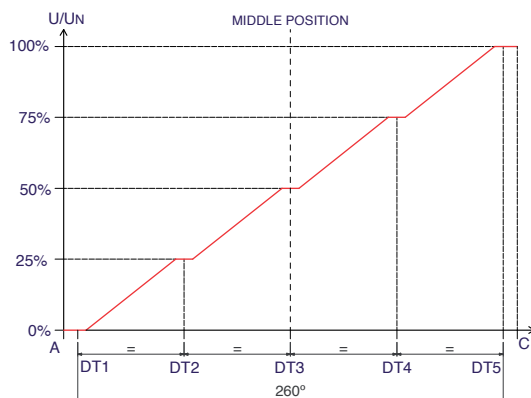

Our patented design with two wipers has improved the performance of these potentiometers, giving them more stable electrical parameters, improved reliability and Contact Resistance Variation (CRV) and narrower tolerances for detent positioning.

For this product, detents are only available under request.

## Terminals

By default, terminals are always straight, as shown on the "models" section. ACP can provide crimped terminals (with snap in, "SNP" or "SNR") to better hold the component to the PCB during the soldering operation.

### SNP

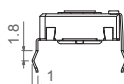

Shorter terminal tips are only available under request.

**Possibilities for insertion of accessories**

Accessories can be mounted on potentiometers through either the front side (WT) or the collector side (WTI). For the specific angular position of shafts with planes, a drawing with the exact position is requested.

**WT**

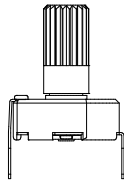

**WTI**

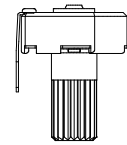

**Shafts**

Shafts are available in different colors (color chart in "how to order" section) and with self-extinguishable property, according to UL 94 V-0, under request. ACP can study special shaft designs. Shafts can be sold separately or delivered already mounted on the potentiometer at ACP. When a shaft is mounted, the distance from the top of the potentiometer to the top of the shaft is marked with "L" in the table below, as shown in the drawings:

**V potentiometer + shaft**

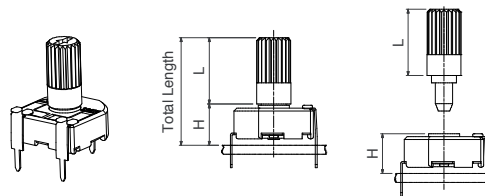

<b>Shaft</b>	14042	14065 (For E rotor)	14117	14056	14081	14187	14251	14067	14008	14015	14066	14084	14250	14072	14073
<b>L Dimension</b>	7.05	11.50	11.70	12.25	18.25	18.75	18.75	27.75	23.25	23.25	23.50	23.50	25.00	31.75	38.50

**14008**

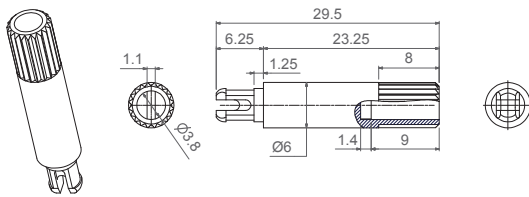

**14015**

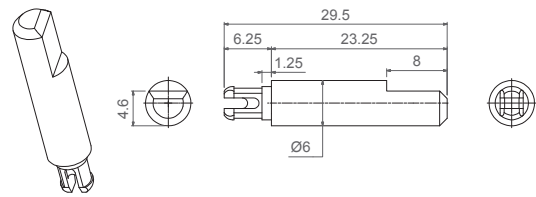

**14042**

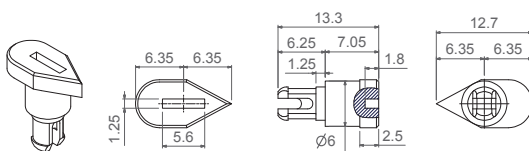

**14056**

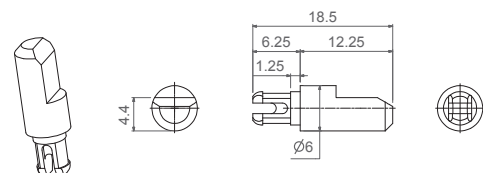

**14065 (Designed for E rotor)**

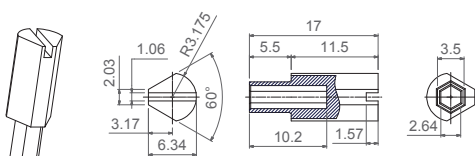

**14066**

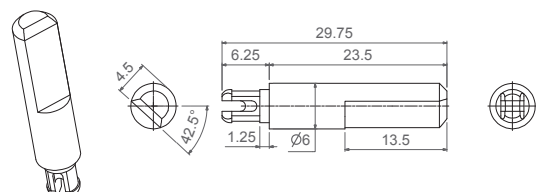



14067

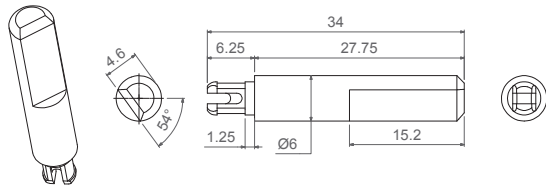

14072

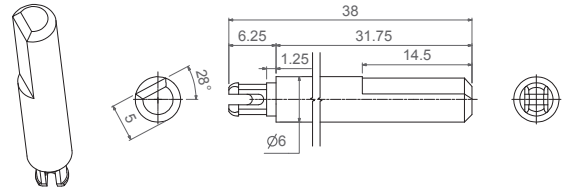

14073

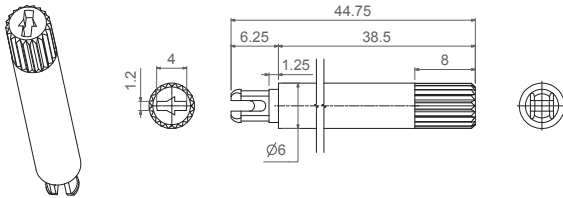

14081

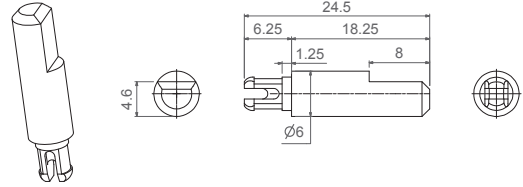

14084

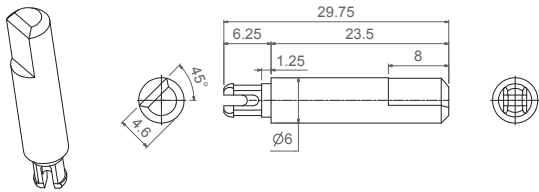

14117

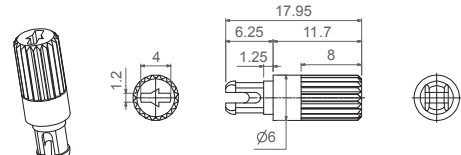

14187

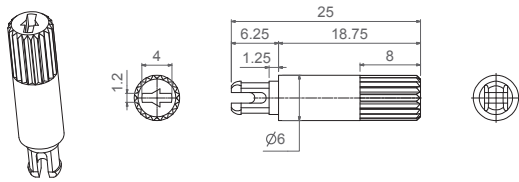

14250

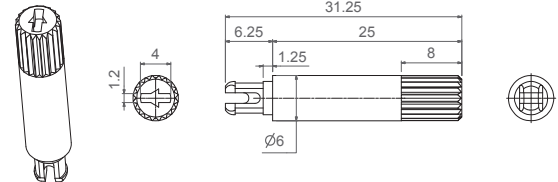

14251

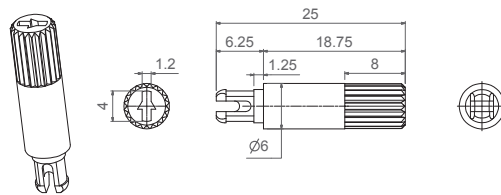

## Thumbwheel

Thumbwheels are available in different colors (color chart in “how to order” section) and with self-extinguishable property according to UL 94 V-0, under request. Thumbwheels can be mounted on the potentiometers at ACP or sold separately. ACP can study special thumbwheel designs.

### 14003

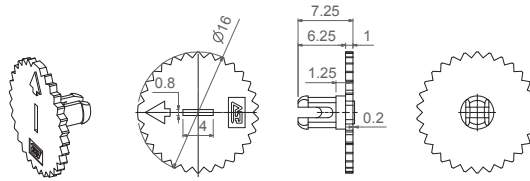

## Packaging

### Bulk packaging:

Potentiometer model	With shaft or thumbwheel inserted?	Pieces per small box (150 x 100 x 70)	Pieces per bigger box (250 x 150 x 70, CG on description)
V15 - VR15	None, only potentiometers.	200 150 for models with*	700
	14003, 14117, 14042, 14056, 14065	100	400 350 for models with*
	14008, 14015, 14066, 14067, 14072, 14073, 14081, 14084, 14187, 14250.	75	To be determined.

For models with \* and an inserted accessory, please, inquire about the quantity per box in that case. Optional box 140x140x70 is available on request.

## Electric Specifications

These are standard features; other specifications and out of range values can be studied on request.

	CAR14 Through-hole	CER14 Through-hole
Range of resistance values* Lin (A) Log (B) Antilog (C)	100Ω ≤ Rn ≤ 5MΩ 1 KΩ ≤ Rn ≤ 2M2Ω	100Ω ≤ Rn ≤ 5MΩ 1 KΩ ≤ Rn ≤ 2M2Ω
Tolerance* Rn < 100Ω: 100Ω ≤ Rn ≤ 100KΩ 100K < Rn ≤ 1MΩ: 1MΩ < Rn ≤ 5MΩ: Rn > 5MΩ:	+50%, -30% (out of range) ±20% ±20% ±30% +50%, -30% (out of range)	- ±20% ±20% ±30% -
Variation laws	Lin (A), Log (B), Antilog (C). Other tapers available on request	
Residual resistance	Lin (A), Log (B), Antilog (C) ≤ 5*10 <sup>-3</sup> *Rn. Minimum value 2Ω	≤2Ω
CRV - Contact Resistance Variation (dynamic)	Lin (A) Electrical Angle 245°±20° ≤ 3%Rn. Other tapers, please inquire	
CRV - Contact Resistance Variation (static)	Lin (A) Electrical Angle 245°±20° ≤ 5%Rn. Other tapers, please inquire	
Maximum power dissipation** Lin (A) Log (B), Antilog (C)	at 50°C 0.25W 0.13W	at 70° C. 0.7W 0.30W
Maximum voltage Lin (A) Log (B), Antilog (C)	250VDC 200VDC	
Operating temperature	-25°C ... +70°C (+85°C on request)	-40°C ... +90°C (+125°C on request)
Temperature coefficient 100Ω ≤ Rn ≤ 10KΩ 10KΩ < Rn ≤ 5MΩ	+200/ -300 ppm +200/ -500 ppm	±100 ppm ±100 ppm

\* Out of range ohm values and tolerances are available on request, please, inquire.

\*\* Dissipation of special tapers will vary, please, inquire.

## Mechanical Specifications

	CAR14 Through-hole	CER14 Through-hole
Resistive element	Carbon technology	Cermet
Angle of rotation (mechanical)	265° ± 5°	
Angle of rotation (electrical)	245° ± 20°	
Wiper standard delivery position	50% ± 15°	
Max. stop torque	10 Ncm	
Max. push/pull on rotor	50 N	
Wiper torque*	<2.5 Ncm Potentiometers with detents: <3.5 Ncm	
Mechanical life	1.000 cycles (many more available on request, please, inquire)	

\* Stronger or softer torque feeling is available on request.

## Test results

The following typical test results (with 95% confidence) are given at 23°C ±2°C and 50% ±25% RH.

	CAR14 Through-hole		CER14 Through-hole	
	Test conditions	Typical variation of Rn	Test conditions	Typical variation of Rn
Damp heat	500 h. at 40°C and 95% RH	+5%, -2%	500 h. at 40°C and 95% RH	±2%
Thermal cycles	16 h at 85°C, plus 2 h at -25°C	±2.5%	16 h at 90°C, plus 2 h at -40°C	±2%
Load life	1.000 h. at 50°C	+0%; -5%	1.000 h. at 70°C	±2%
Mechanical life	1.000 cycles at 10 c.p.m. and at 23°C ± 2°C	±3%	1.000 cycles at 10 c.p.m. and at 23°C ± 2°C	±2%
Storage (3 years)	3 years at 23°C ± 2°C	±3%	3 years at 23°C ± 2°C	±1%

**CAR14 Through-hole**

**CER14 Through-hole**

Power derating curve:

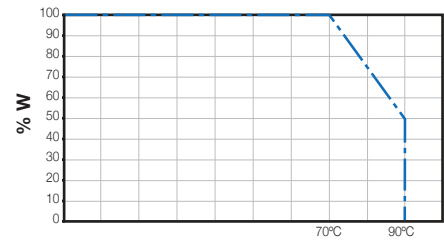
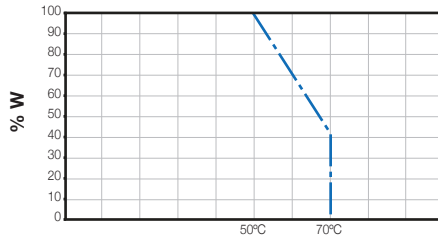

**For temperatures out of range**

The normal operation temperature for a carbon ACP potentiometer is -25°C to +70°C. When the temperature goes up to 85°C, the following variations should be observed:

Load life	1.000 h. at 50°C	+0%; -6%	1.000 h. at 85°C	+0%; -15%
-----------	------------------	----------	------------------	-----------

The power derating curve to consider is:

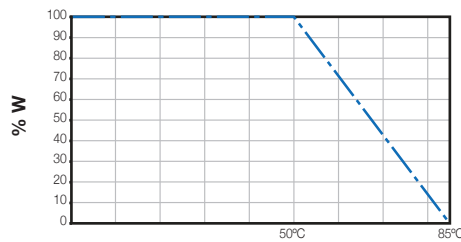

Representation of the typical variation of nominal resistance (with 95% confidence) throughout the ohm value range:

**CAR14 Through-hole**

**CER14 Through-hole**

Damp heat

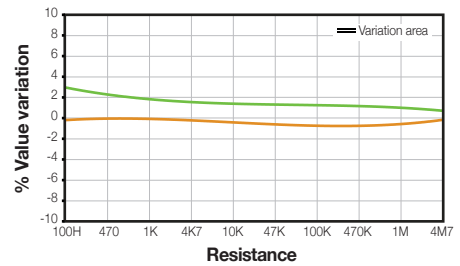
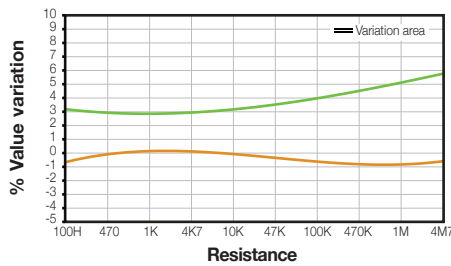

Temperature Coefficient

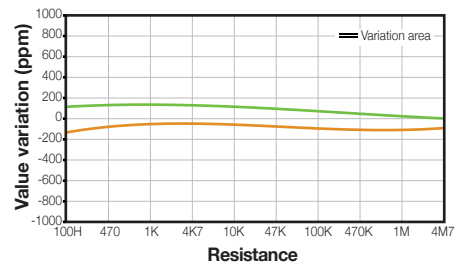
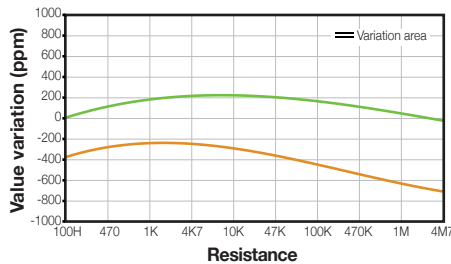

Load life

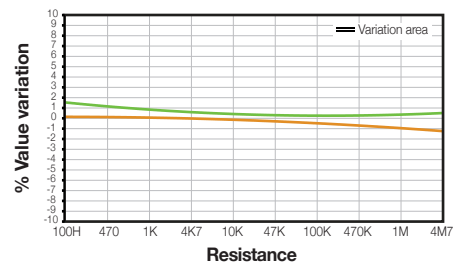
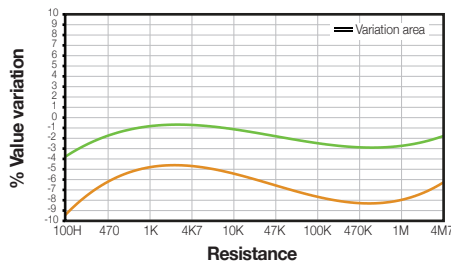

Mechanical life

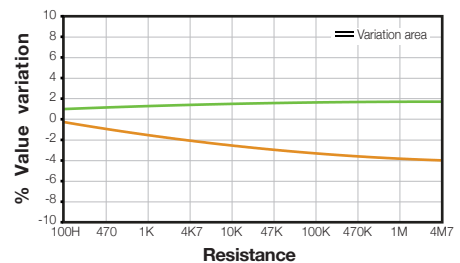
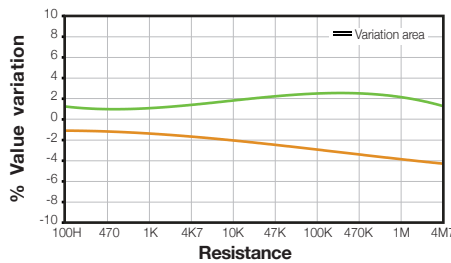

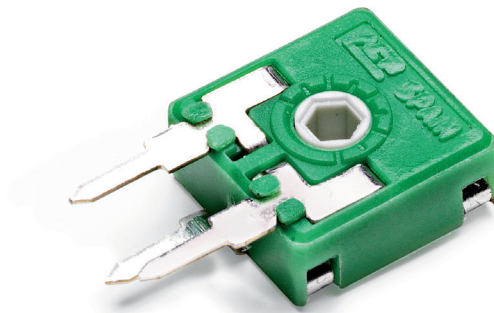
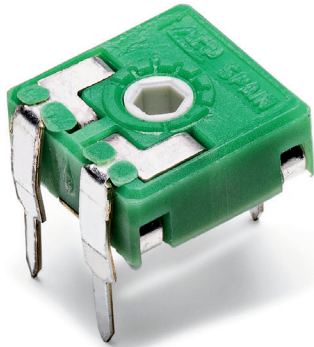
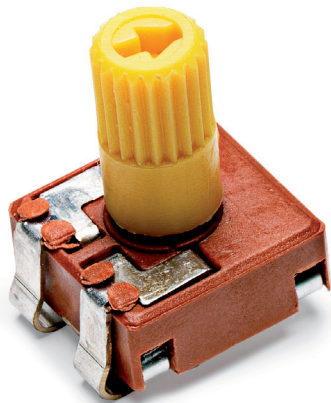

## RS9

9mm Rotary Sensor appropriated for position sensing and control applications capable of withstanding high configurations of mechanical life.

- Standard: from 25.000 to 50.000 cycles
- Long life: up to 200.000 cycles. More cycles available under request.

RS9 has plastic housing and Ingress Protection rating type IP 54 (high level of protection against dust and also against water splashing), according to IEC 60529. Plastic materials can be self-extinguishable according to UL 94 V-0 under request.

Through-hole and SMD configurations are available. Terminals and collector are manufactured in tinned brass, although versions with steel terminals are also available under request. Terminals for through-hole models can be provided straight or crimped, which helps hold the component to the PCB during soldering.

Standard taper is linear, with independent linearity of  $\pm 3\%$ . ACP can study other special tapers (even cut tracks, step curves with areas of constant value, etc), as well as more strict linearity.

Thumbwheels and shafts can be provided either separately or already inserted in the sensor. Our RS9 can be manufactured in a wide range of possibilities regarding: resistance value, tolerance, tapers, pitch, positioning of the wiper, housing and rotor color.

### Applications

- Household appliances: temperature control, position sensor.
- Automotive: position adjustment and sensing. Industrial controls.

# RS9 HOW TO ORDER

EXAMPLE: **RS9MH2,5-10KA2020 SNP PI WT-9005-BA**

Standard features								Extra features							Assembled accessory			
Series	Rotor	Model	Packg.	Ohm value	Taper	Tol.	Life	Track	Detents	Snap in	Housing	Rotor	Wiper	Lin.	Assembly	Ref #	Color	Flam.
1	2	3	4	5	6	7	8	9	10	11	12	13	14	15	16			
RS9	M	H2,5		- 10K	A	2020				SNP			PI		WT	-9005	-BA	-V0

Standard configuration:	RS9 Through-hole	RS9 SMD
Dimensions:	9mm	
Protection:	IP 54 (dust-proof) On request: Self-extinguishable, to meet UL 94 V-0	
Substrate:	Carbon technology	Carbon technology, special for high temperature
Color:	Green housing + white rotor	Brown housing + grey rotor
Packaging:	Bulk	
Wiper position:	at 50% ±15°	
Terminals:	Straight, without crimping.	
Marking:	Resistive value marked on housing. Others on request.	

**Customized products:** A drawing is requested when ordering a customized product. Series, rotor, model and total resistive value are indicated before the code that includes all special specifications. Example: CA9PH2,5-10K CODE C00111.

## 1 - Series

■ RS9

## 2 - Rotors

C D E J K M P R Y

## 3 - Model and pitch

H2,5 H3,8 HS3,8 H5 HSMD V7,5 V10 VK10 VR10 VSMD VSMD WT-9002

## 4 - Packaging

### Trough-hole

### SMD models

Bulk	(blank)... <sup>(1)</sup>	(blank)... <sup>(1)</sup>
T&R (Tape and 13" reel)	(N.A.) <sup>(2)</sup>	T&R
T&R (Tape and 15" reel)	(N.A.) <sup>(2)</sup>	T&R15

(1) If blank, bulk packaging is implied. (2) N.A., Not Applicable: Tape and Reel packaging is only available for SMD terminals.

## 5 - Resistance value

10K

The RS9 has 10K, linear taper and ±30% by default. Other resistive values, tolerances and tapers (log, antilog, cut tracks, constant value areas, etc.) can be studied on request. Please, enclose a drawing when ordering special tapers.

## 6 - Resistance law / taper

Lin - Linear	A
- Special tapers have codes assigned:	CODE YXXXXX

## 7 - Tolerance

±30%

3030

## 8 - Operating Life (Cycles)

Standard: between 25.000-50.000 cycles ex:LV25; LV50

Long life: LV+the number of cycles. ex: LV200 for 200.000 cycles. (others on request) LVXXX:ex: LV200

## 9 - Cut Track – Open circuit.

Open circuit at beginning of track, fully CCW	PCI
Open circuit at end of track, fully CW	PCF
Pin in Paste option (Reflow Soldering)	PIP

## 10 - Detents (DT)

Not applicable for RS9

## 11 - Terminals

SNAP IN P	SNP
SNAP IN J	SNJ
Shorter tip of terminal, TPXX, where XX is tip length (under request)	TPXX, ex: TP25
Steel Terminals	SH

## 12 - Housing

**Color:** For colors other than standard: -See color chart below- CJ-color, ex., red: CJ-RO

## 13 - Rotor

**Color:** For colors other than standard: -See color chart below- RT-color; ex., blue: RT-AZ

### \* Self-extinguishable property, V0, for housing and rotor:

By default, carbon is non self-extinguishable. Self-extinguishable property can be added. V0 means housing and rotor are V0. If only the housing needs to be V0, then CJ-V0. If only rotor: RT-V0

## 14 - Wiper

**Wiper position** (Standard: 50% ± 15%) (leave blank)

Initial or CCW PI

Final or CW PF

Others: following clock positions; at 3 hours: P3H PXH, ex: P3H

**Wiper torque** (Standard: <2Ncm) (leave blank)

Stronger or softer torque feeling is available on request.

## 15 - Linearity

Standard Independent Linearity LN3%

Other Independent linearity below x%, for example, 4%: LN4% LNx%; ex: LN4%

Absolute linearity controlled & below x% LAx% LAx%

## 16 - Potentiometers with assembled accessories

Assembled from terminal side WT

Assembled from collector side WTI

Accessory Reference -XXXXX

See list of shafts and thumbwheels available Example: 9010

Color of shaft or thumbwheel -YY Example, white: BA

Non self-extinguishable. Self-extinguishable according to standard UL 94 (leave blank)

(-V0 in box 17 modifies only the accessory, please, note.) -V0

**For ordering spare accessories:** Accessory reference - color- flammability.

Ex. 9010-AZ-V0 is a blue self-extinguishable 9010 thumbwheel XXXX-YY-V0

## Color chart for rotor, housing and accessories

Black <sup>(1)</sup>	White	Neutral	Transp.	Red	Green	Yellow	Blue	Grey	Brown
NE	BA	IN	TA	RO	VE	AM	AZ	GS	MR

(1) black is not an option for housings.

## Rotors

Rotors are drawn in their standard positioning, 50% of rotation. Alternative delivery positioning can be requested. Accessories in this catalogue are designed for the M rotor, unless otherwise stated.

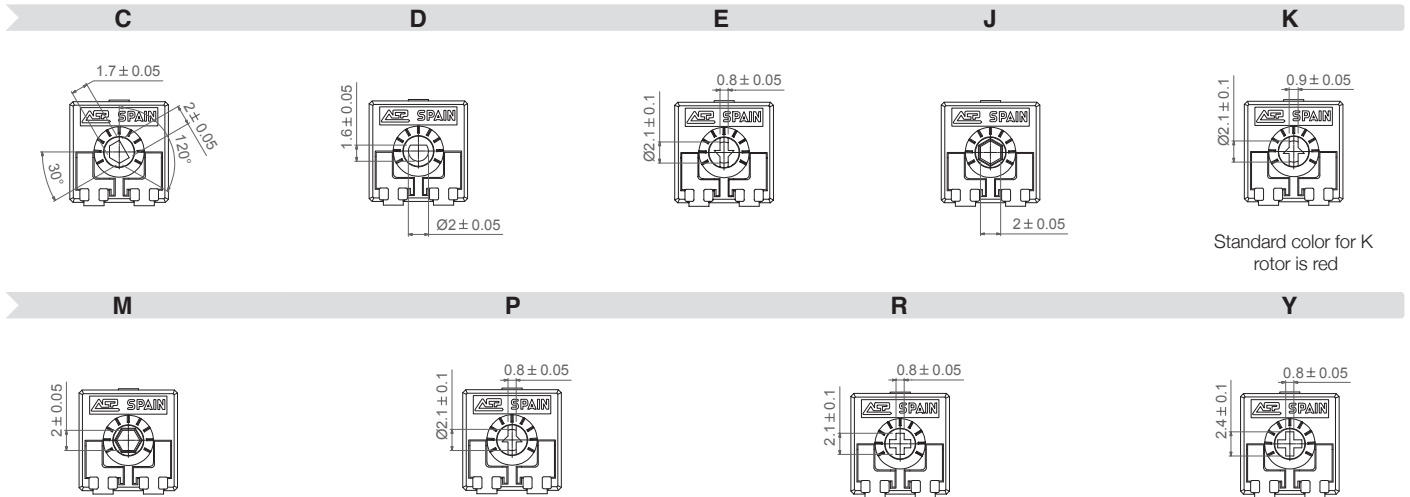

## Models

All models shown here have the most common rotor for 9mm potentiometers: the M rotor. Different rotors are available from the menu above.

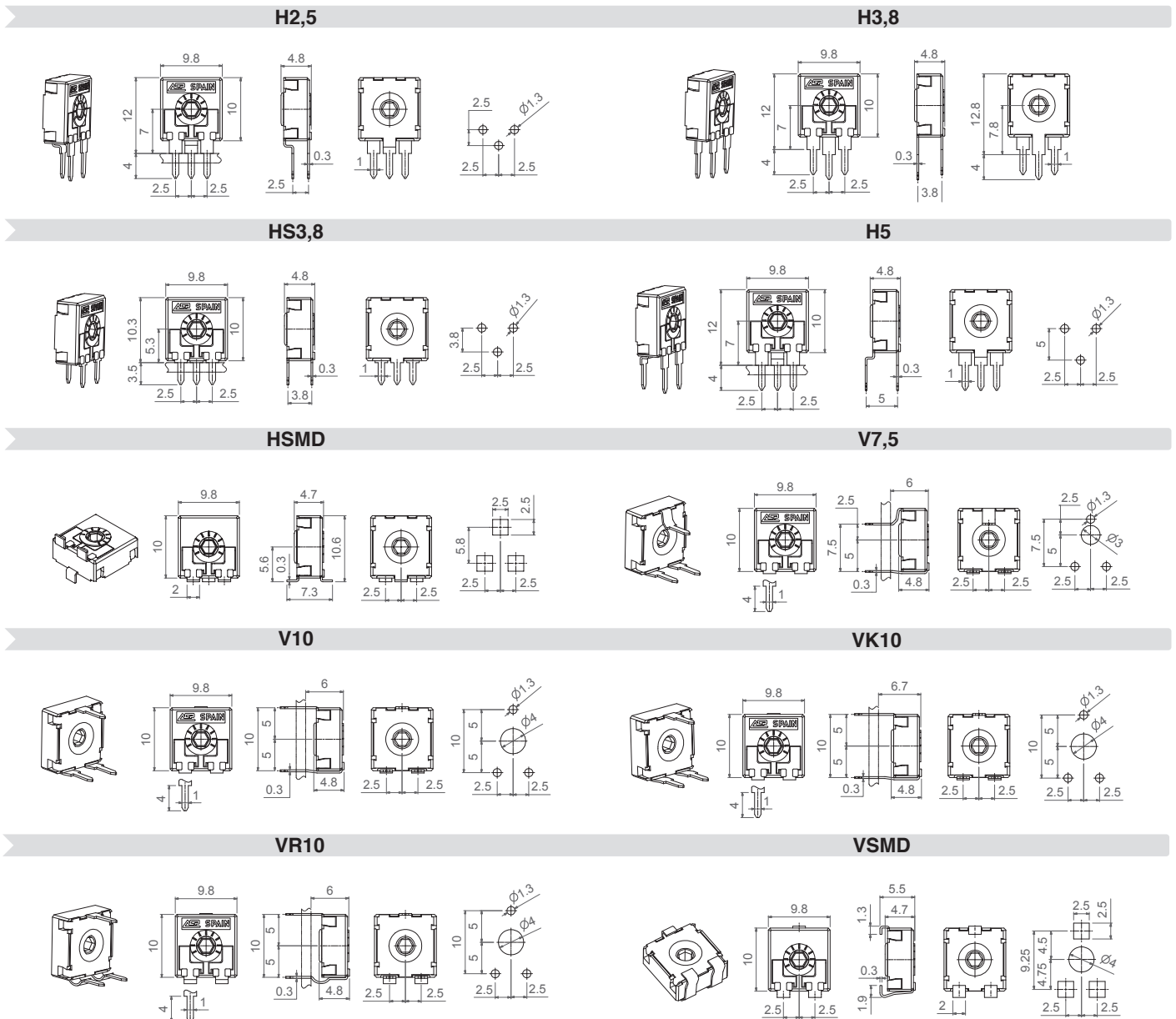



VSMD WT-9002

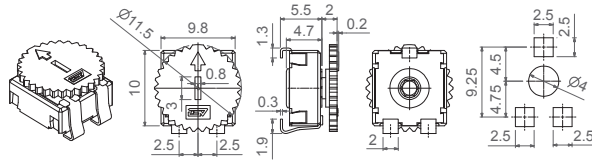

VSMD...CY

VSMD...CY WT-9002

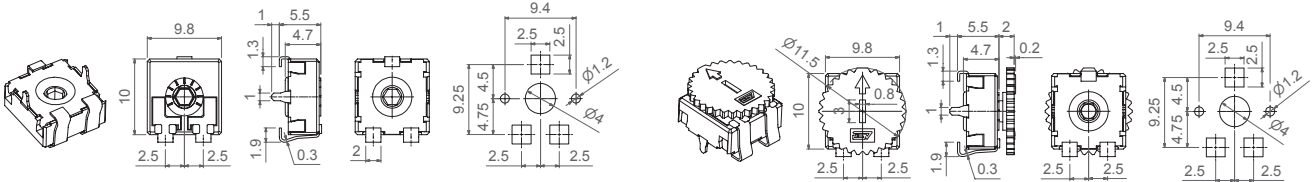

Tapers

The standard taper is linear (A) and the standard ohm value is 10K, since a RS9 will normally be used as a voltage divider. For other tapers, please, inquire.

Voltage Divider

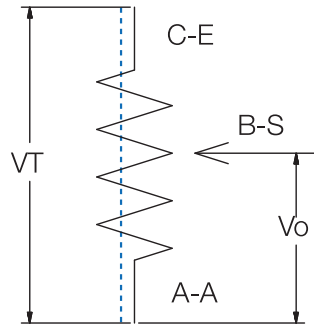

Potentiometers with cut track

The cut track is an area with very high resistive value, resulting in an open circuit. It is widely used in lighting applications. Mechanical life with cut track needs to be confirmed.

PCI = Cut at initial position, when the potentiometer is turned fully counter clockwise.

PCF = Cut at final position, when the potentiometer is turned fully clockwise.

Other positions are available on request.

PCI

PCF

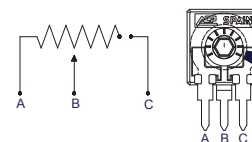
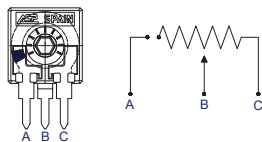

## Terminals

By default, terminals are always straight, as shown on the “models” section. ACP can provide crimped terminals (with snap in, “SNP” or “SNJ”) to better hold the component to the PCB during the soldering operation.

### SNP

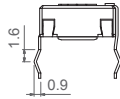

### SNJ

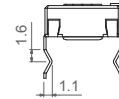

Also, there is an option of having shorter terminal tips:

### Standard Terminal

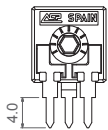

### Shorter terminal, for H5 TP25

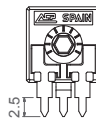

### Shorter terminal, TPXX (under request)

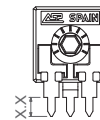

## Possibilities for insertion of accessories

Accessories can be mounted on potentiometers through either the front side (WT) or the collector side (WTI). For the specific angular position of shafts with planes, a drawing with the exact position is requested.

### WT Front side

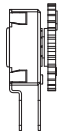

### WTI Collector side



### WT Front side

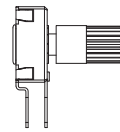

### WTI Collector side

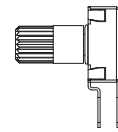

## Shafts

Shafts are available in different colors (color chart in “how to order” section) and with self-extinguishable property, according to UL 94 V-0, under request. ACP can study special shaft designs.

Shafts can be sold separately or delivered already mounted on the potentiometer at ACP.

Unless otherwise stated, the arrow in the shafts is in line with the wiper and it points to 50% when assembled with M rotors.

When a shaft is mounted on a potentiometer, the distance from the top of the potentiometer to the top of the shaft is marked with “L” in the table below, as shown in the drawings:

### H potentiometer + shaft

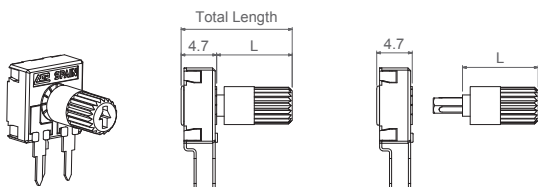

### V potentiometer + shaft

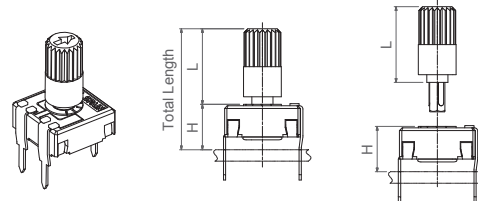

Shaft	9071	9067	9072	9054	9004	9005	9064	9055	9070	9053	9009	9059	9063	9010	9006	9019	9073	9020	9047
L Dimension	3.5	5.5	6.5	9.5	10	10	10	10.8	11.9	12.1	14.5	14.5	14.5	15	19.7	19.9	25.5	25.9	29.8

### 9004

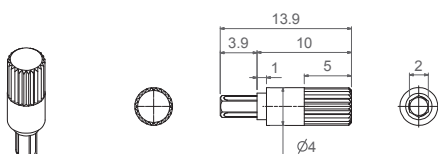

### 9005

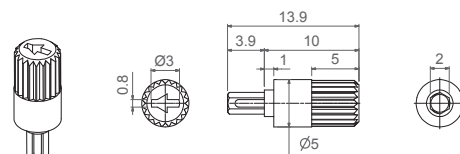

9006

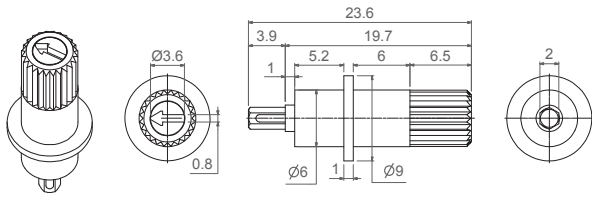

9009

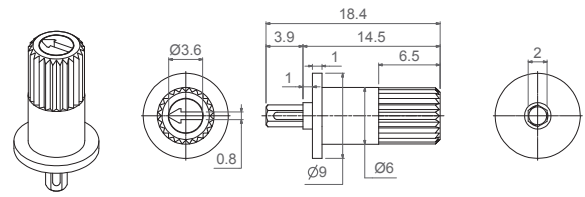

9010

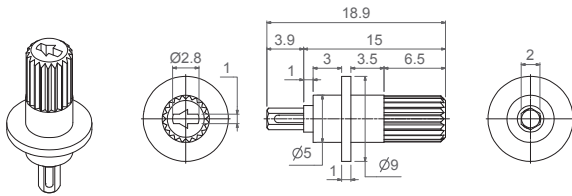

9019 (Designed for D rotor)

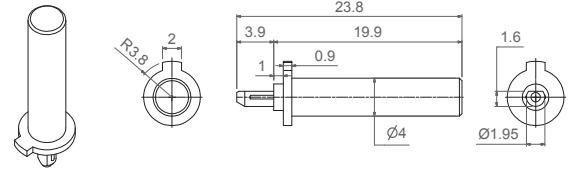

9020 (Designed for D rotor)

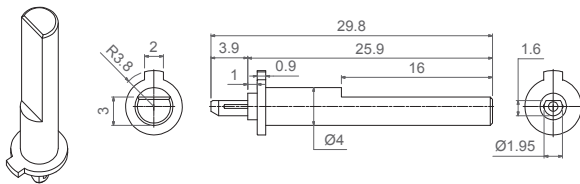

9047

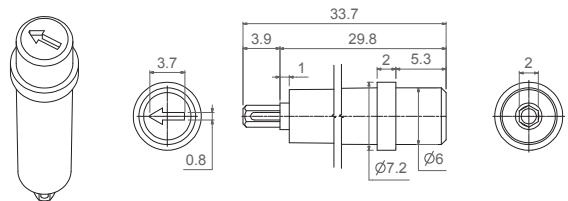

9053

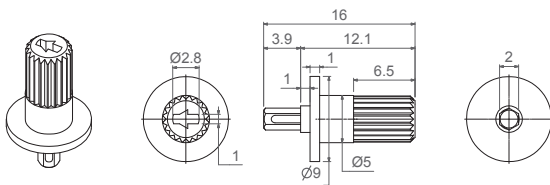

9054

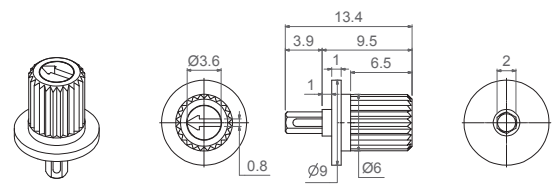

9055

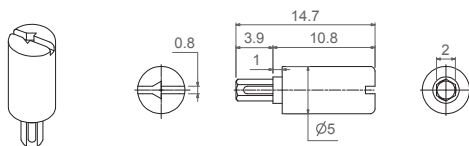

9059

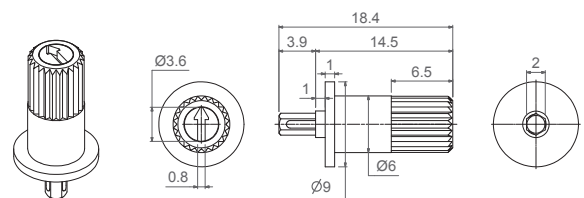

The arrow is in line with the wiper when potentiometer has rotor J (with M rotor, there is a 30° difference).

9063

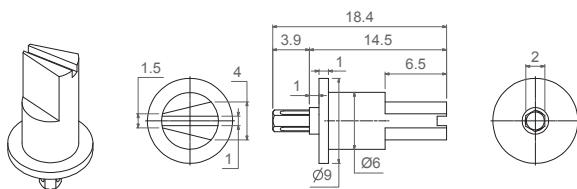

9064

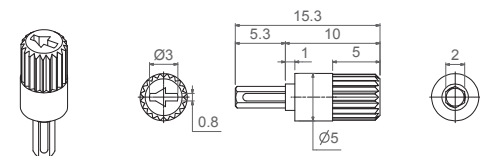

9067

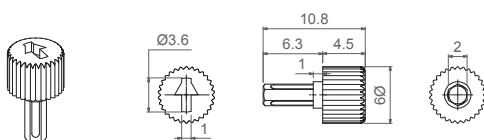

9070

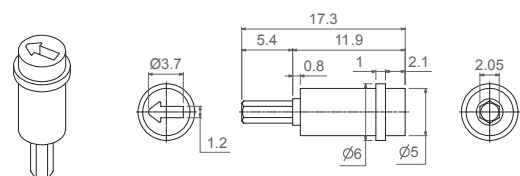

The arrow is in line with the wiper when potentiometer has rotor J (with M rotor, there is a 30° difference).

## Shafts

9071

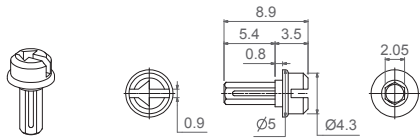

9072

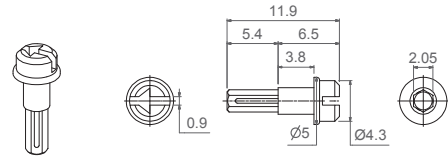

9073

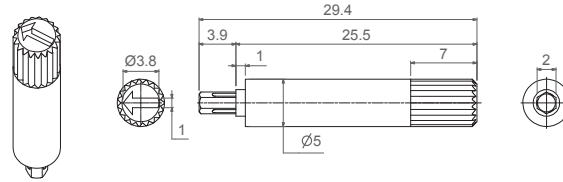

## Thumbwheel

Thumbwheels are available in different colors (color chart in "how to order" section) and with self-extinguishable property according to UL 94 V-0, under request. Thumbwheels can be mounted on the potentiometers at ACP or sold separately. ACP can study special thumbwheel designs.

9002

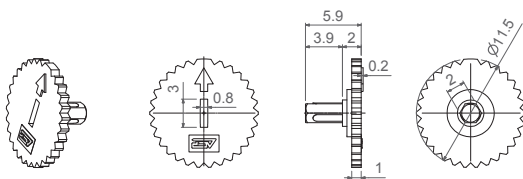

9041

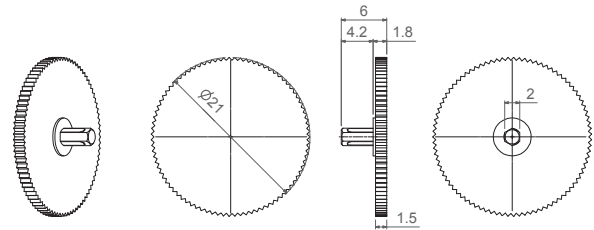

9060 (Designed for R rotor)

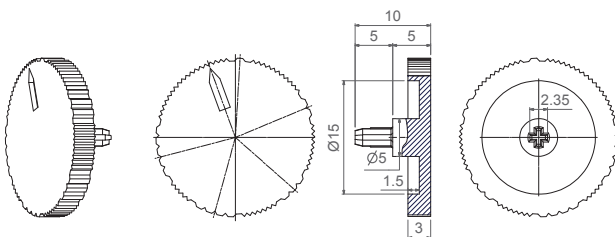

9061

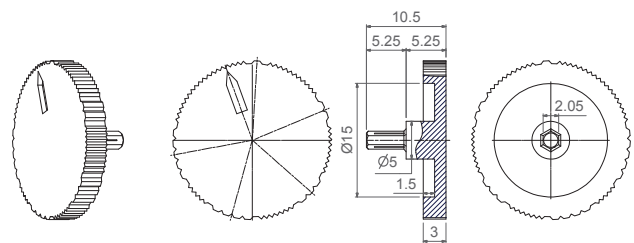

## Gear Wheels

In addition to the range of shafts and thumbwheels we can provide gear wheels under study according to customer's requirements. The below model is already available for prototyping purposes. It can be supplied loose or already mounted on the RS9 series

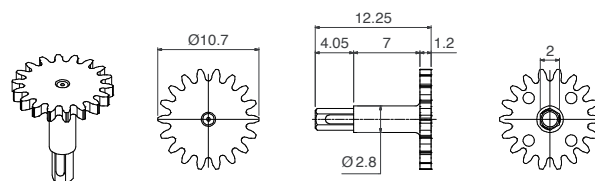

## Packaging

### Bulk packaging:

Potentiometer model	With shaft or thumbwheel inserted?	Pieces per small box (150 x 100 x 70)	Pieces per bigger box (250 x 150 x 70, CG on description)
H2,5 - H3,8 - HS3,8 - H5 HSMD - V7,5 - V10 VK10 - VR10 - VSMD	None, only potentiometers.	500	1.500
	9002	250	1.000
	9004, 9005, 9006, 9009, 9010, 9041, 9047, 9053, 9054, 9055, 9059, 9060, 9061, 9063, 9064, 9067, 9070.	200	1.000 in general
	9071, 9072	400	1.250

### Tape & Reel packaging:

	With thumbwheel inserted?	13" Reel (Standard), with 24mm width tape	15" Reel, with 24mm width tape
VSMD	None, only potentiometers.	900 pcs per reel, 12mm step between cavities.	1.250 pcs per reel, 12mm step between cavities.
	9002	700 pcs per reel, 12mm step between cavities.	To be determined.
VSMD...CY	None, only potentiometers.	750 pcs per reel, 12 mm step between cavities	1000 pcs per reel, 12 mm step between cavities
	9002	To be determined	To be determined
HSMD		350 pcs per reel, 16 mm step between cavities	475 pcs per reel, 16 mm step between cavities
H2,5...PIP TP25 - H5...PIP TP25 - HS3,8... PIP	None, only potentiometers or 9002	250	350
V7,5...PIP - V10...PIP - V10...PIP TP25 - VR10...PIP		250	400

The 13" reel is the standard. For the 15" reel, T&R15 is added to the description.

**VSMD-T&R**

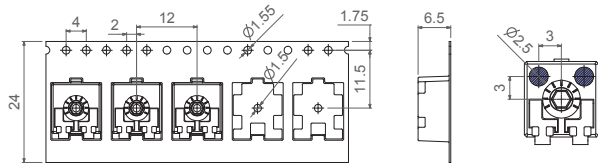

**VSMD-T&R...WT-9002**

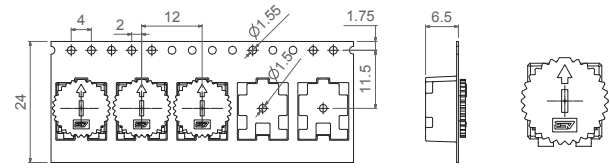

**VSMD-T&R ...CY**

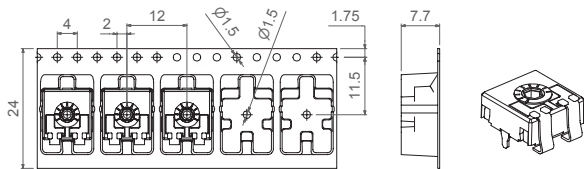

**VSMD-T&R...CY WT-9002**

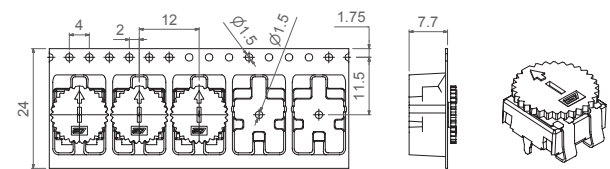

**HSMD-T&R**

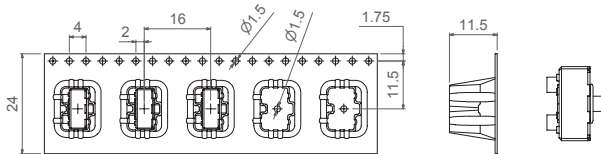

**13" Reel**

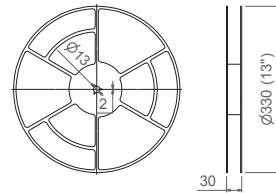

**15" Reel**

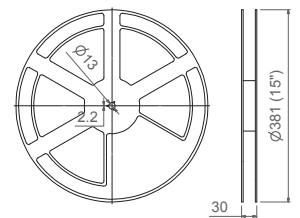

**V7,5-T&R...PIP**

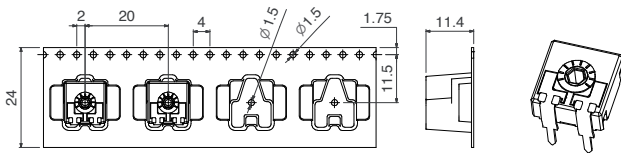

**V7,5-T&R... PIP WT-9002**

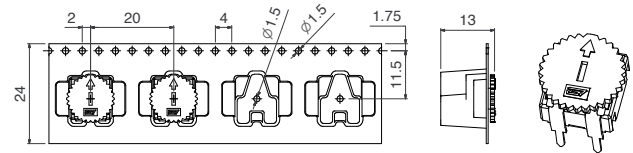

**V10-T&R... PIP**

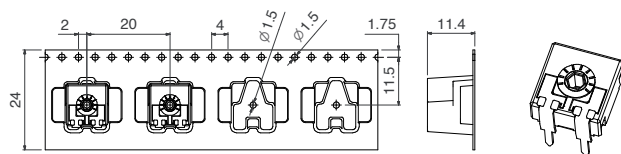

**V10-T&R...PIP WT-9002**

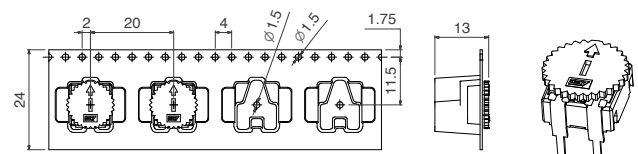

**V10-T&R...PIP TP25**

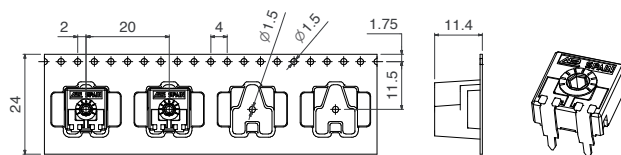

**V10-T&R...PIP TP25 WT-9002**

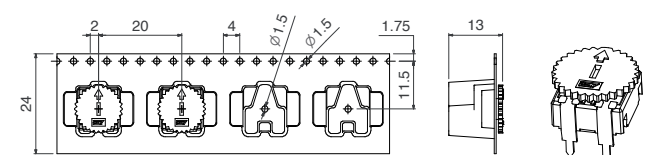

VR10-T&R...PIP

VR10-T&R... PIP WT-9002

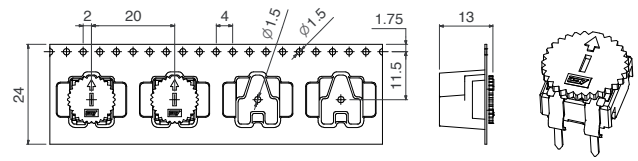
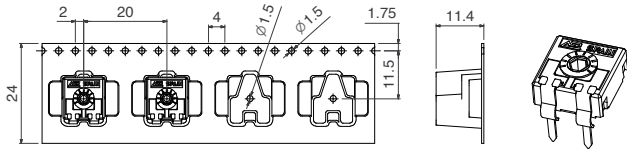

HS3,8-T&R... PIP

H5-T&R...PIP TP25

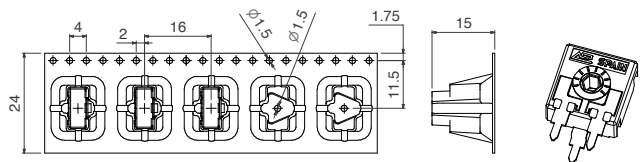
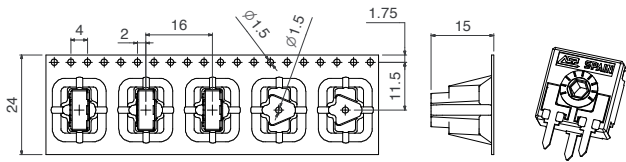

H2,5-T&R...PIP TP25

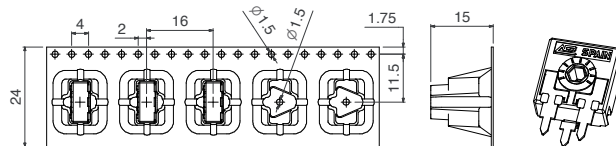

## Electric Specifications

These are standard features; other specifications and out of range values can be studied on request.

### RS9 Through-hole and SMD

Range of resistance values* Lin (A) Log (B) Antilog (C)	100Ω ≤ Rn ≤ 5MΩ 1 KΩ ≤ Rn ≤ 2M2Ω	100Ω ≤ Rn ≤ 1MΩ 1 KΩ ≤ Rn ≤ 1 MΩ
Tolerance* Rn < 100Ω: 100Ω ≤ Rn ≤ 100KΩ 100K < Rn ≤ 1MΩ: 1MΩ < Rn ≤ 5MΩ: Rn > 5MΩ:	+50%, -30% (out of range) ±20% ±20% ±30% +50%, -30% (out of range)	- ±30% ±40% ±50% -
Variation laws	Lin (A). Other tapers available on request	
Residual resistance	Lin (A) ≤ 5*10 <sup>-3</sup> *Rn. Minimum value 2Ω	
CRV - Contact Resistance Variation (dynamic)	Lin (A) Electrical Angle 220°±20° ≤ 3%Rn. Other tapers, please inquire	
CRV - Contact Resistance Variation (static)	Lin (A) Electrical Angle 220°±20° ≤ 5%Rn. Other tapers, please inquire	
Maximum power dissipation** Lin (A) Log (B), Antilog (C)	at 50°C 0.15W 0.10W	
Maximum voltage Lin (A) Log (B), Antilog (C)	200VDC 150VDC	
Operating temperature	-25°C ... +70°C (+85°C on request)	
Temperature coefficient 100Ω ≤ Rn ≤ 10KΩ 10KΩ < Rn ≤ 5MΩ	+200/ -300 ppm +200/ -500 ppm	+200/ -500 ppm +200/ -1000 ppm

\* Out of range ohm values and tolerances are available on request, please, inquire.

\*\* Dissipation of special tapers will vary, please, inquire.

## Mechanical Specifications

### RS9 Through-hole and SMD

Resistive element	Carbon technology
Angle of rotation (mechanical)	240° ± 5°
Angle of rotation (electrical)	220° ± 20°
Wiper standard delivery position	50% ± 15°
Max. stop torque	5 Ncm
Max. push/pull on rotor	40 N
Wiper torque*	<2 Ncm
Mechanical life	Standard: between 25.000 and 50.000cycles. Long life: up to 200.000cycles (more available on request, please, inquire)

\* Stronger or softer torque feeling is available on request.

## Test results

The following typical test results are given at 23°C ±2°C and 50% ±25% RH.

### RS9 Through-hole and SMD

	Test conditions	Typical variation of nominal resistance
Damp heat	500 h. at 40°C and 95% RH	±20%
Thermal cycles	16 h at 85°C, plus 2 h at -25°C	±20%
Load life	1.000 h. at 50°C	±20%
Mechanical life	1.000 cycles at 10 c.p.m. and at 23°C ± 2°C	±20%
Storage (3 years)	3 years at 23°C ± 2°C	±20%

Power derating curve:

### RS9 Through-hole and SMD

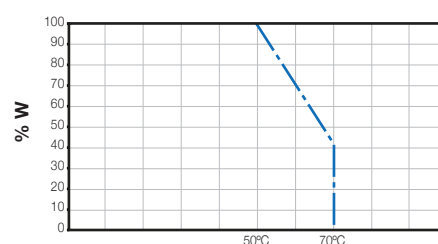



RS14   
Rotary Sensor

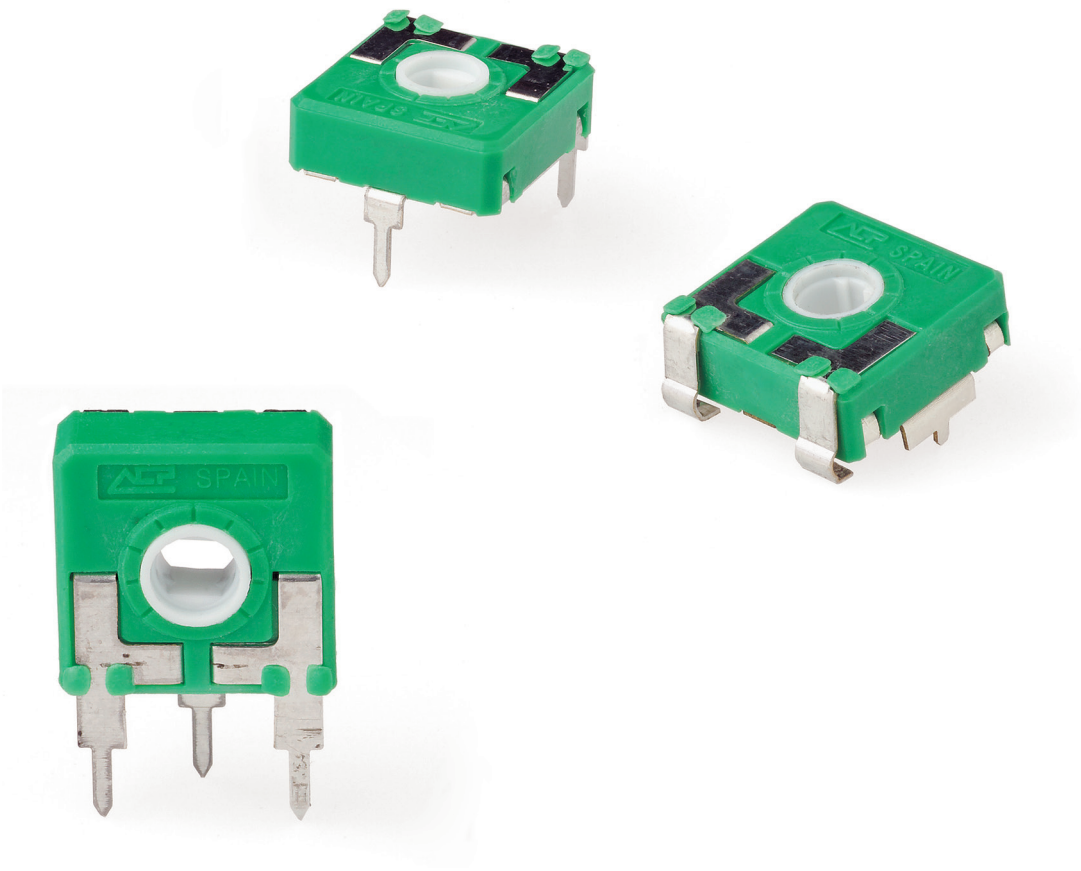

## RS14

14mm Rotary Sensor with up to 1.000.000 cycles of mechanical life depending on configuration, making it particularly appropriate for control applications.

RS14 has plastic housing and Ingress Protection rating type IP 54 (high level of protection against dust and also against water splashing), according to IEC 60529. Plastic materials can be self-extinguishable according to UL 94 V-0 under request.

Through-hole and SMD configurations are available. Terminals and collector are manufactured in tinned brass, although versions with steel terminals are also available under request. Terminals for through-hole models can be provided straight or crimped, which helps hold the component to the PCB during soldering.

Standard taper is linear, with linearity of  $\pm 3\%$ . ACP can study other special tapers (even cut tracks, step curves with areas of constant value, etc), as well as more strict linearity.

Thumbwheels and shafts can be provided either separately or already inserted in the sensor. Our RS14 can be manufactured in a wide range of possibilities regarding: resistance value, tolerance, tapers, pitch, positioning of the wiper, housing and rotor color.

### Applications

- Household appliances: temperature control, position sensor.
- Automotive: position adjustment and sensing.
- Industrial controls.

# RS14 HOW TO ORDER

EXAMPLE: **RS14TV15-10KA3030 WT-14008-NE-V0**

Standard features								Extra features							Assembled accessory			
Series	Rotor	Model	Packg.	Ohm value	Taper	Tol.	Life	Track	Detents	Snap in	Housing	Rotor	Wiper	Lin.	Assembly	Ref #	Color	Flam.
1	2	3	4	5	6	7	8	9	10	11	12	13	14	15	16			
RS14	T	V15		- 10K	A	3030									WT	-14008	-NE	-V0

Standard configuration:	RS14 Through-hole	RS14 SMD
Dimensions:	14mm	
Protection:	IP 54 (dust-proof) On request: Self-extinguishable, to meet UL 94 V-0	
Substrate:	Carbon technology	Carbon technology, special for high temperature
Color:	Green housing + white rotor	Green housing + grey rotor
Packaging:	Bulk	
Wiper position:	at 50% ±15°	
Terminals:	Straight, without crimping.	
Marking:	Resistive value marked on housing. Others on request.	

**Customized products:** A drawing is requested when ordering a customized product. Series, rotor, model and total resistive value are indicated before the code that includes all special specifications. Example: RS14TV15-10K CODE C00111.

## 1 - Series

■ RS14

## 2 - Rotors

F N T Y Z

## 3 - Model and pitch

H0 H0 H2,5 H4 H5 HA5 HL5 V12,5 VA12,5 VL12,5  
 VR12,5 V15 VJ15 (V15)... CFF V17,5 VD7,5 VD11 VSMD VSMD ... CY  
 HSMD (Under request, not readily available)

## 4 - Packaging

	Trough-hole	SMD models
Bulk	(blank)... <sup>(1)</sup>	(blank)... <sup>(1)</sup>
T&R (Tape and 13" reel)	(N.A.) <sup>(2)</sup>	T&R
T&R (Tape and 15" reel)	(N.A.) <sup>(2)</sup>	T&R15

(1) If blank, bulk packaging is implied. (2) N.A., Not Applicable: Tape and Reel packaging is only available for SMD terminals.

## 5 - Resistance value

10K

The RS14 has 10K, linear taper and ±30% by default. Other resistive values, tolerances and tapers (log, antilog, cut tracks, constant value areas, etc.) can be studied on request. Please, enclose a drawing when ordering special tapers.

## 6 - Resistance law / taper

Lin - Linear A  
 - Special tapers have codes assigned: CODE YXXXXX

## 7 - Tolerance

±30%

3030

## 8 - Operating Life (Cycles)

Long life: LV + number of cycles. i.e: LV100 for 100.000 cycles, LV150, LV1M LVXXX: ex: LV100

## 9 - Cut Track – Open circuit.

Open circuit at beginning of track, fully CCW PCI  
 Open circuit at end of track, fully CW PCF

## 10 - Detents (DT)

Not applicable for RS14

## 11 - Terminals

SNAP IN P SNP  
 SNAP IN J SNJ  
 Shorter tip of terminal, TPXX, where XX is tip length (under request) TPXX, ex: TP30  
 Steel Terminals SH

## 12 - Housing

**Color:** For colors other than standard: -See color chart below- CJ-color, ex., red: CJ-RO

## 13 - Rotor

**Color:** For colors other than standard: -See color chart below- RT-color; ex., blue: RT-AZ

## \* Self-extinguishable property, V0, for housing and rotor:

By default, carbon is non self-extinguishable. Self-extinguishable property can be added. V0 means housing and rotor are V0. (blank) V0  
 If only the housing needs to be V0, then CJ-V0. CJ-V0, RT-V0  
 If only rotor: RT-V0

## 14 - Wiper

**Wiper position** (Standard: 50% ± 15%) (leave blank)

Initial or CCW PI  
 Final or CW PF

Others: following clock positions; at 3 hours: P3H PXH, ex: P3H

**Wiper torque** (Standard: <1.5Ncm) (leave blank)

Stronger or softer torque feeling is available on request.

## 15 - Linearity

Standard linearity 3% (leave blank)

Independent linearity controlled & below x%, for example, 2%: LN2% LNx%; ex: LN2%

Absolute linearity controlled & below x% LAx%

Other features could be available on request, please, ask.

## 16 - Potentiometers with assembled accessories

Assembled from terminal side WT

Assembled from collector side WTI

Accessory Reference -XXXXX Example: 14117

See list of shafts and thumbwheels available

Color of shaft or thumbwheel -YY Example, white: BA

Non self-extinguishable. Self-extinguishable according to standard UL 94 (-V0 in box 17 modifies only the accessory, please, note.) (leave blank) -V0

**For ordering spare accessories:** Accessory reference - color- flammability. Ex. 14117-AZ-V0 is a blue self-extinguishable 14117 thumbwheel XXXX-YY-V0

## Color chart for rotor, housing and accessories

Black <sup>(1)</sup>	White	Neutral	Transp.	Red	Green	Yellow	Blue	Grey	Brown
NE	BA	IN	TA	RO	VE	AM	AZ	GS	MR

(1) black is not an option for housings.

## Rotors

T is the standard rotor for RS14. Rotors are drawn in their standard positioning, 50% of rotation. Alternative delivery positioning can be requested.

Accessories in this catalogue are designed for N, Z and T rotors, unless otherwise stated. Other rotor styles, on request.

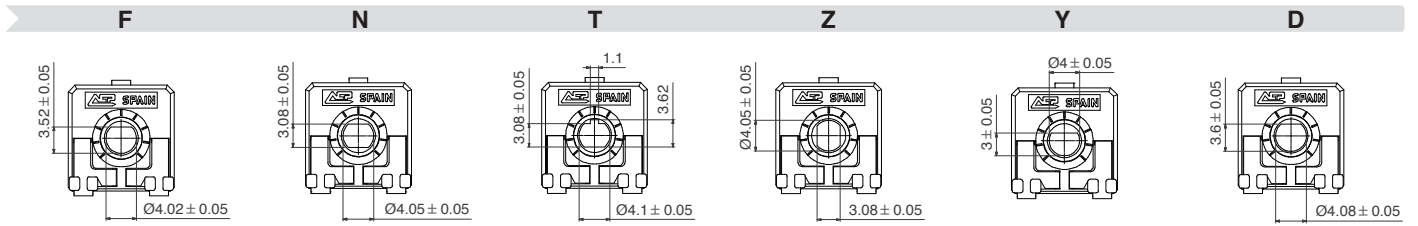

Standard color for F rotor is red

## Models

All models shown here have the most common rotor for RS14, the T rotor.

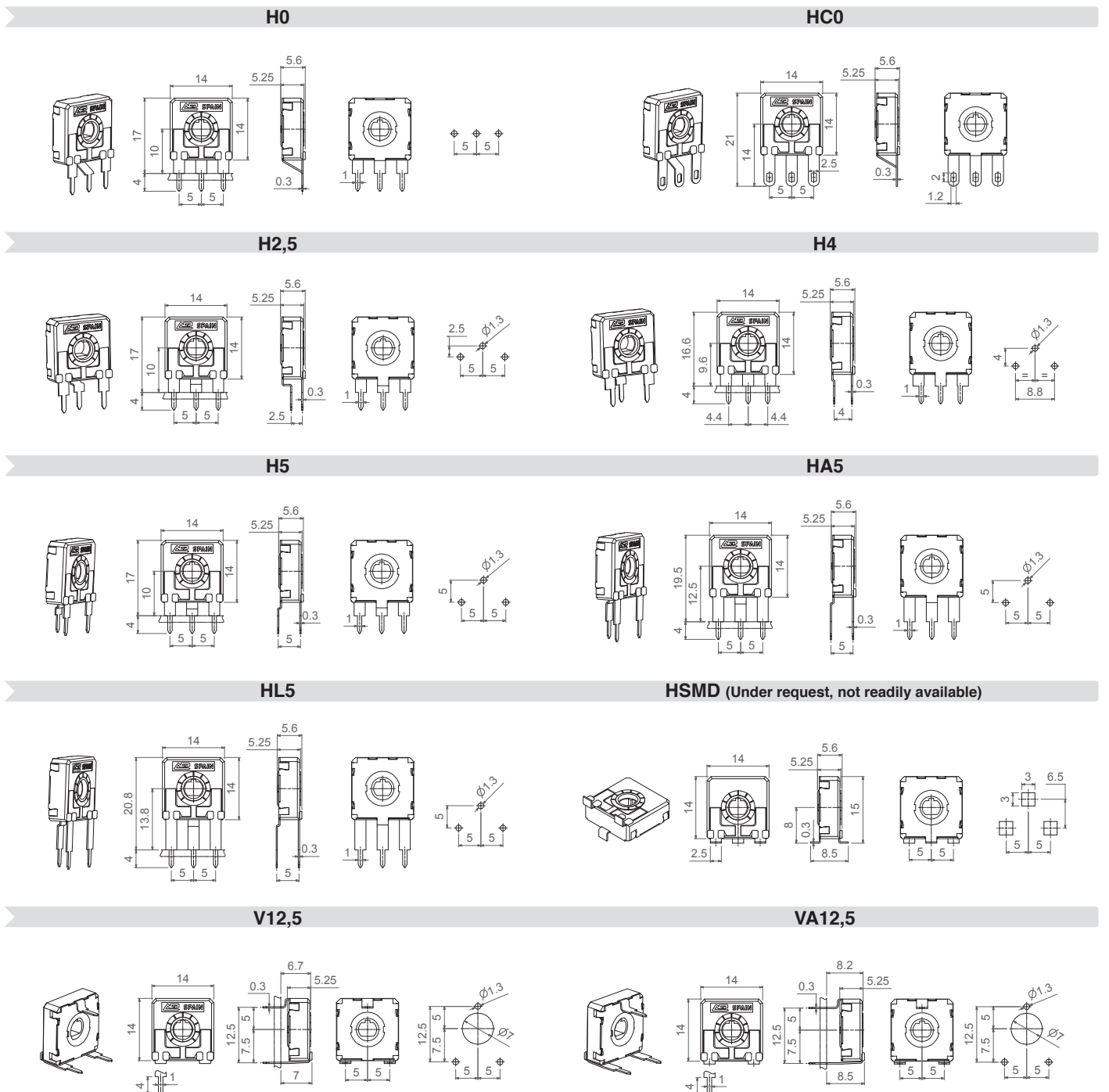

VL12,5

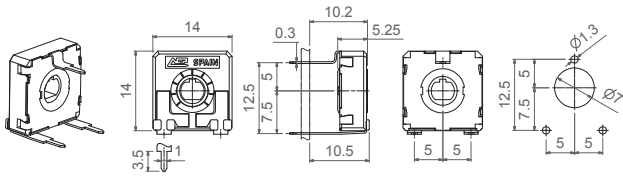

VR12,5

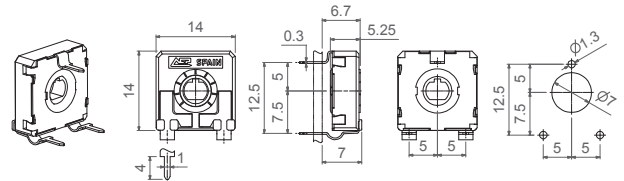

V15

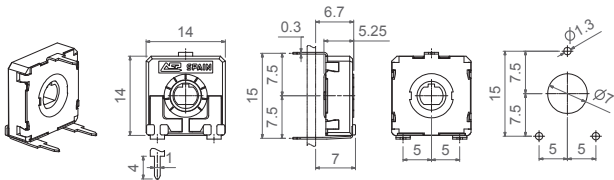

VJ15

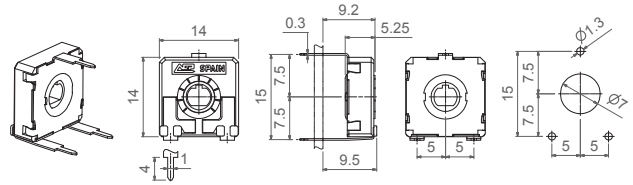

V15...CFF

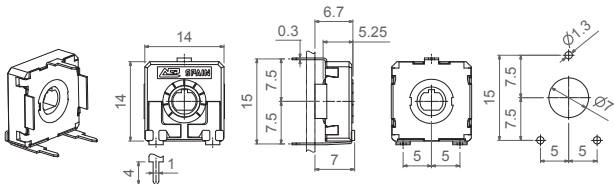

V17,5

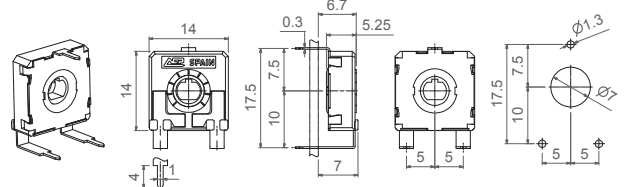

VD7,5

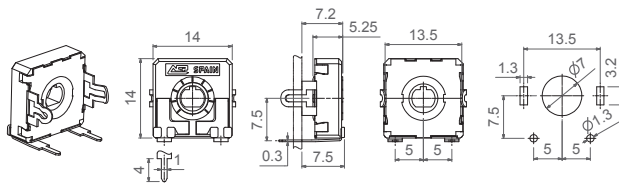

VD11

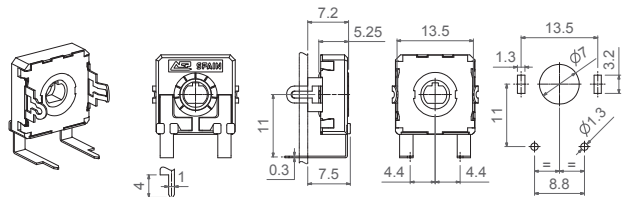

VSMD

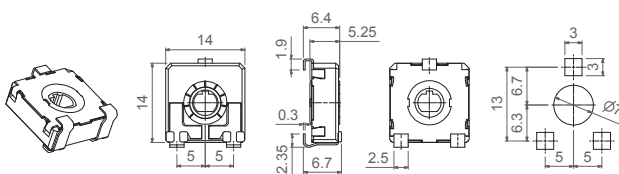

VSMD...CY

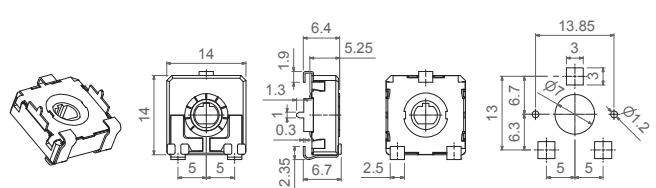

Tapers

The standard taper is linear (A) and the standard ohm value is 10K, since a RS14 will normally be used as a voltage divider. For other tapers, please, inquire.

Voltage Divider

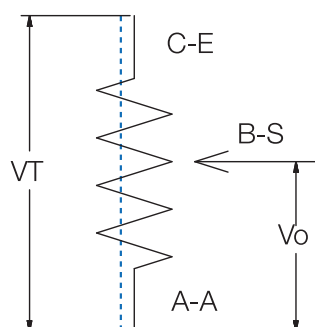

## Potentiometers with cut track

The cut track is an area with very high resistive value, resulting in an open circuit. It is widely used in lighting applications. Mechanical life available with cut track needs to be confirmed case by case.  
 PCI = Cut at initial position, when the potentiometer is turned fully counter clockwise.  
 PCF = Cut at final position, when the potentiometer is turned fully clockwise.  
 Other positions are available on request.

### PCI

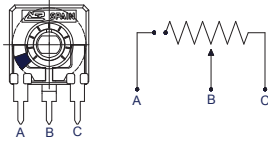

### PCF

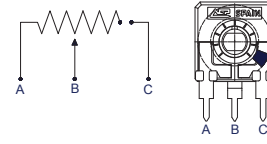

## Terminals

By default, terminals are always straight, as shown on the “models” section. ACP can provide crimped terminals (with snap in, “SNP” or “SNR”) to better hold the component to the PCB during the soldering operation.

### SNP

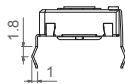

### SNR

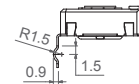

Also, there is an option of having shorter terminal tips.

### Standard Terminal

### Shorter terminal, for V12,5 TP30

### Shorter terminal, TPXX (under request)

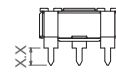
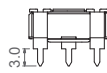
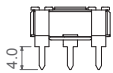

## Possibilities for insertion of accessories

Accessories can be mounted on potentiometers through either the front side (WT) or the collector side (WTI). For the specific angular position of shafts with planes, a drawing with the exact position is requested.

### WT Front side

### WTI Collector side

### WT Front side

### WTI Collector side

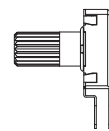
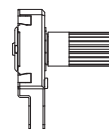
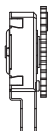

## Shafts

Shafts are available in different colors (color chart in “how to order” section) and with self-extinguishable property, according to UL 94 V-0, under request. ACP can study special shaft designs.

Shafts can be sold separately or delivered already mounted on the potentiometer at ACP.

When a shaft is mounted on a potentiometer, the distance from the top of the potentiometer to the top of the shaft is marked with “L” in the table below, as shown in the drawings:

### H potentiometer + shaft

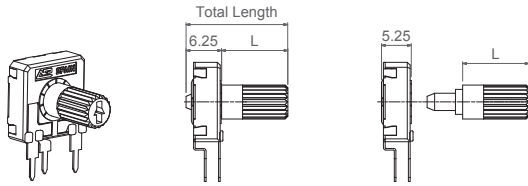

### V potentiometer + shaft

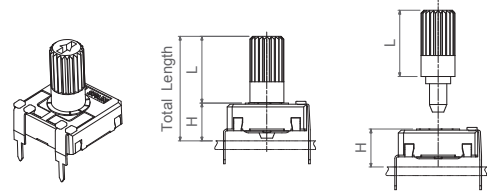

Shaft	14042	14065 (For E rotor)	14117	14056	14081	14187	14251	14067	14008	14015	14066	14084	14250	14072	14073
L Dimension	7.05	11.50	11.70	12.25	18.25	18.75	18.75	27.75	23.25	23.25	23.50	23.50	25.00	31.75	38.50

### 14008

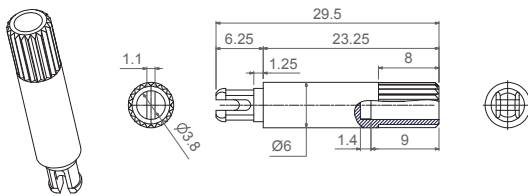

### 14015

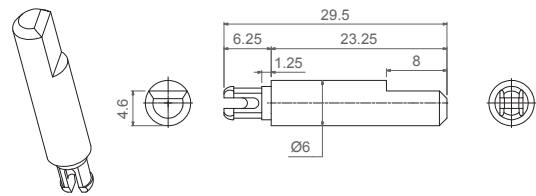

### 14042

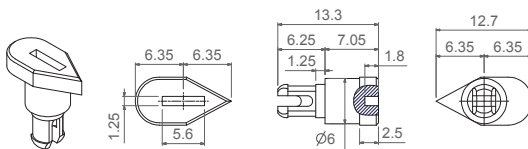

### 14056

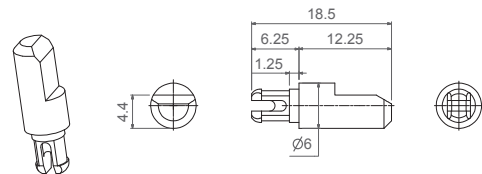

### 14065 (Designed for E rotor)

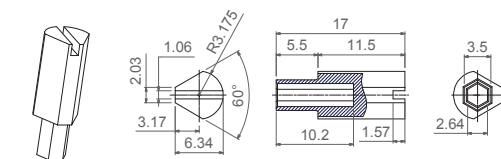

### 14066

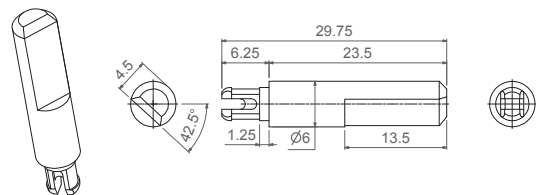

### 14067

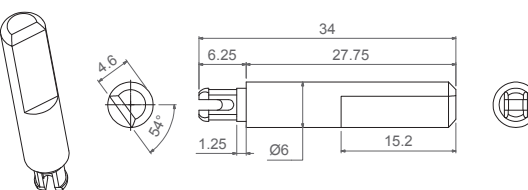

### 14072

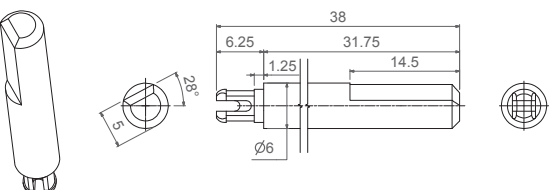

## Shafts

14073

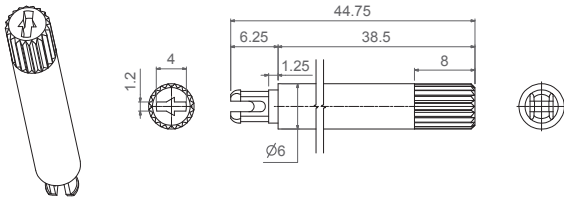

14081

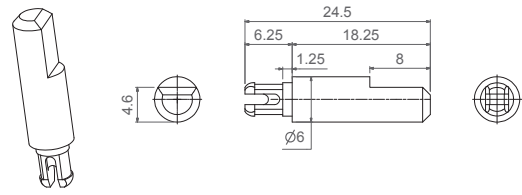

14084

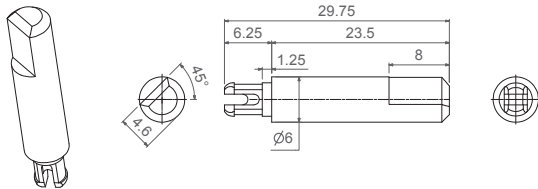

14117

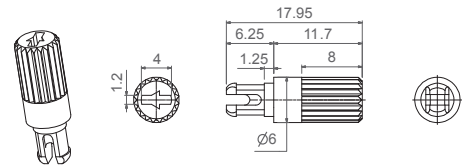

14187

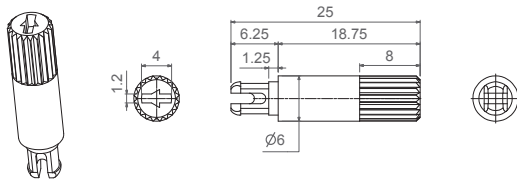

14250

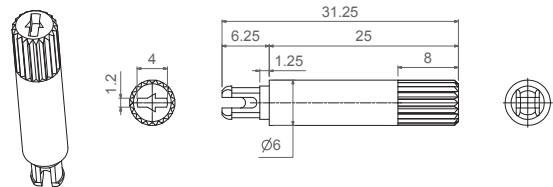

14251

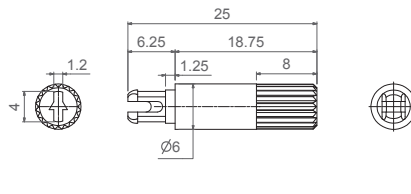

## Thumbwheel

Thumbwheels are available in different colors (color chart in "how to order" section) and with self-extinguishable property according to UL 94 V-0, under request. Thumbwheels can be mounted on the potentiometers at ACP or sold separately. ACP can study special thumbwheel designs.

14003

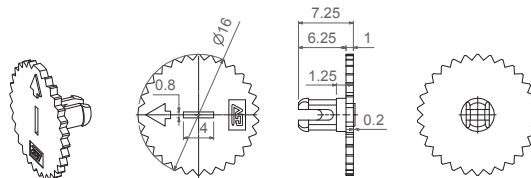



**Bulk packaging:**

RS14 model	With shaft or thumbwheel inserted?	Pieces per small box (150 x 100 x 70)	Pieces per bigger box (250 x 150 x 70, CG on description)
H2,5 - H4 - H5- HA5- HL5- H0 HCO - V12,5 - V15 - VA12,5 VL12,5 - VJ15 - V17,5* VD11* - VD7,5* - VR12,5	None, only potentiometers.	200 150 for models with*	700 600 for VJ15 - V17,5 - VD7,5 500 for VD11
	14003, 14117, 14042, 14056, 14065	100	400 350 for models with*
	14008, 14015, 14066, 14067, 14072, 14073, 14081, 14084, 14187, 14250.	75	To be determined.

For models with \* and an inserted accessory, please, inquire about the quantity per box in that case.

**Tape & Reel packaging:**

	With thumbwheel inserted?	13" Reel (Standard), with 24mm width tape	15" Reel, with 24mm width tape
VSMD	None, only potentiometers.	500 pcs per reel, 16mm step between cavities.	800 pcs per reel, 16mm step between cavities.
	14003	450 pcs per reel, 16mm step between cavities.	To be determined.
VSMD... CY	None, only potentiometers.	350 pcs per reel, 20mm step between cavities.	500 pcs per reel, 20mm step between cavities.
	14003	To be determined.	To be determined.

The 13" reel is the standard. For the 15" reel, T&R15 is added to the description.

**VSMD-T&R**

**VSMD-T&R...WT-14003**

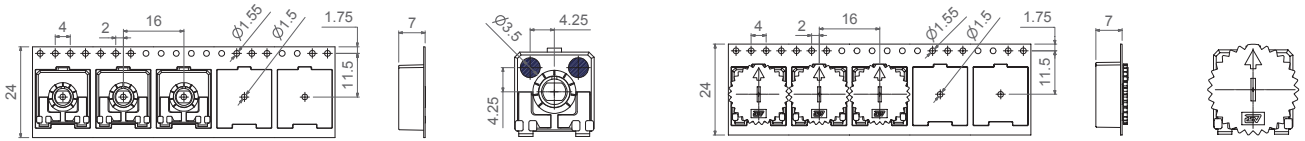

**VSMD-T&R ... CY**

**VSMD-T&R...CY WT-14003**

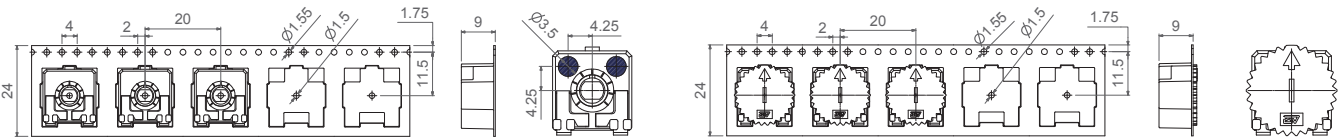

**13" Reel**

**15" Reel**



## Electric Specifications

These are standard features; other specifications and out of range values can be studied on request.

	RS14 Through-hole	RS14 SMD
Range of resistance values* Lin (A)	Standard value is 10K, as voltage divider use is supposed	
Tolerance*	30%	
Variation laws	Lin (A). Other tapers available on request	
Residual resistance	Minimum value 2Ω	
CRV - Contact Resistance Variation (dynamic)	Lin (A) Electrical Angle 245°±20° ≤ 3%Rn. Other tapers, please inquire	
CRV - Contact Resistance Variation (static)	Lin (A) Electrical Angle 245°±20° ≤ 5%Rn. Other tapers, please inquire	
Maximum power dissipation** Lin (A)	at 50°C, 0.15W	
Maximum voltage Lin (A)	250VDC	
Operating temperature	-25°C ... +85°C	
Linearity	3%	
Temperature coefficient 100Ω ≤ Rn ≤ 10KΩ 10KΩ < Rn ≤ 5MΩ	+200/ -300 ppm +200/ -500 ppm	+200/ -500 ppm +200/ -1000 ppm

\* Out of range ohm values and tolerances are available on request, please, inquire.

\*\* Dissipation of special tapers will vary, please, inquire.

## Mechanical Specifications

### RS14 Through-hole and SMD

Resistive element	Carbon technology
Angle of rotation (mechanical)	265° ± 5°
Angle of rotation (electrical)	245° ± 20°
Wiper standard delivery position	50% ± 15°
Max. stop torque	10 Ncm
Max. push/pull on rotor	50 N
Wiper torque*	<1.5 Ncm
Mechanical life	Up to 1.000.000 cycles (please, specify the cycles needed).

\* Stronger or softer torque feeling is available on request.

## Test results

The following typical test results (with 95% confidence) are given at 23°C ±2°C and 50% ±25% RH. Maximum linearity after mechanical tests: 4%.

### RS14 Through-hole and SMD

	Test conditions	Typical variation of Rn
Damp heat	500 h. at 40°C and 95% RH	±20%
Temperature Coefficient	16 h at 85°C, plus 2 h at -25°C	±20%
Load life	1.000 h. at 50°C	±20%
Mechanical life	150.000 cycles at 10 c.p.m. and at 23°C ± 2°C	±20%
Storage (3 years)	3 years at 23°C ± 2°C	±3%

Power derating curve:

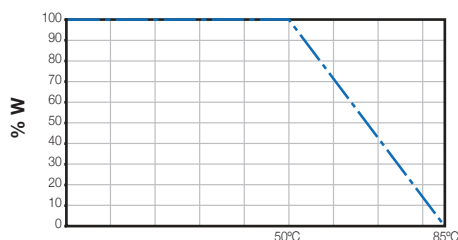

# RSR14

Rotary Sensor

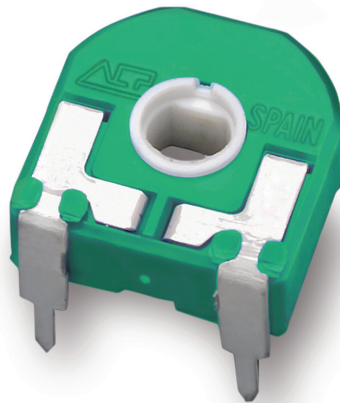
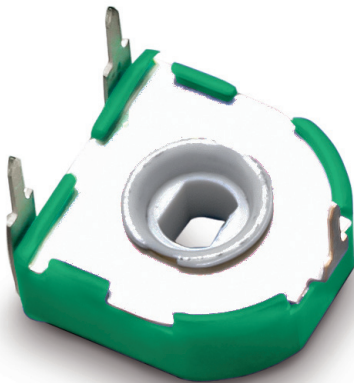

## RSR14

This product family born as an alternative to the RS14 series when curved designs appear. Housing shape has been modified in order to set the product properly.

14mm Rotary Sensor appropriated for position sensing and control applications capable of withstanding high configurations of mechanical life.

- Standard: 100.000, 150.000 or 250.000 cycles
- Long life, up to 1 million turns (please, inquiry)

RSR14 has plastic housing and Ingress Protection rating type IP 54 (high level of protection against dust and also against water splashing), according to IEC 60529. Plastic materials can be self-extinguishable according to UL 94 V-0 under request.

Through-hole configurations is available; for SMD version, please inquire. Terminals and collector are manufactured in tinned brass, although versions with steel terminals are also available under request. Terminals for through-hole models can be provided straight or crimped, which helps hold the component to the PCB during soldering.

Standard taper is linear, with independent linearity of  $\pm 3\%$ . ACP can study other special tapers (even cut tracks, step curves with areas of constant value, etc), as well as more strict linearity.

Thumbwheels and shafts can be provided either separately or already inserted in the sensor. Our RSR14 can be manufactured in a wide range of possibilities regarding: resistance value, tolerance, tapers, pitch, positioning of the wiper, housing and rotor color.

### Applications

- Household appliances: temperature control, position sensor.
- Automotive: position adjustment and sensing.
- Industrial controls.

# RS14 HOW TO ORDER

EXAMPLE: **RSR14TV15-10KA3030 WT-14008-NE-V0**

Standard features								Extra features							Assembled accessory			
Series	Rotor	Model	Packg.	Ohm value	Taper	Tol.	Life	Track	Detents	Snap in	Housing	Rotor	Wiper	Lin.	Assembly	Ref #	Color	Flam.
1	2	3	4	5	6	7	8	9	10	11	12	13	14	15		16		
RSR14	T	V15		- 10K	A	3030									WT	-14008	-NE	-V0

Standard configuration:	RSR14 Through-hole
Dimensions:	14mm
Protection:	IP 54 (dust-proof) On request: Self-extinguishable, to meet UL 94 V-0
Substrate:	Carbon technology
Color:	Green housing + white rotor
Packaging:	Bulk
Wiper position:	at 50% ±15°
Terminals:	Straight, without crimping.
Marking:	Resistive value marked on housing. Others on request.

**Customized products:** A drawing is requested when ordering a customized product. Series, rotor, model and total resistive value are indicated before the code that includes all special specifications. Example: RSR14TV15-10K CODE C00111.

## 1 - Series

■ RSR14

## 2 - Rotors

F N T D Y Z

## 3 - Model and pitch

V15

## 4 - Packaging

### Trough-hole

### SMD models

Bulk (blank)...<sup>(1)</sup> (blank)...<sup>(1)</sup>

(1) If blank, bulk packaging is implied. (2) N.A., Not Applicable: Tape and Reel packaging is only available for SMD terminals.

## 5 - Resistance value

10K

The RSR14 has 10K, linear taper and ±30% by default. Other resistive values, tolerances and tapers (log, antilog, cut tracks, constant value areas, etc.) can be studied on request. Please, enclose a drawing when ordering special tapers.

## 6 - Resistance law / taper

Lin - Linear A  
- Special tapers have codes assigned: CODE YXXXXX

## 7 - Tolerance

±30%

3030

## 8 - Operating Life (Cycles)

Standard: 100.000 cycles: LV100  
150.000 cycles: LV150  
250.000 cycles: LV250  
Long life: LV + number of cycles. i.e: LV100 for 300.000 cycles, LV300, LV1M LVXXX: ex: LV300

## 9 - Cut Track – Open circuit.

Open circuit at beginning of track, fully CCW PCI  
Open circuit at end of track, fully CW PCF

## 10 - Detents (DT)

Not applicable for RSR14

## 11 - Terminals

SNAP IN P SNP  
Shorter tip of terminal, TPXX, where XX is tip length (under request) TPXX, ex: TP25  
Steel Terminals SH

## 12 - Housing

**Color:** For colors other than standard: -See color chart below- CJ-color, ex., red: CJ-RO

## 13 - Rotor

**Color:** For colors other than standard: -See color chart below- RT-color; ex., blue: RT-AZ

### \* Self-extinguishable property, V0, for housing and rotor:

By default, carbon is non self-extinguishable. Self-extinguishable property can be added. V0 means housing and rotor are V0. (blank)  
If only the housing needs to be V0, then CJ-V0. V0  
If only rotor: RT-V0. CJ-V0, RT-V0

## 14 - Wiper

**Wiper position** (Standard: 50% ± 15°) (leave blank)  
Initial or CCW PI  
Final or CW PF  
Others: following clock positions; at 3 hours: P3H PXH, ex: P3H  
**Wiper torque** (Standard: <1.5Ncm) (leave blank)  
Stronger or softer torque feeling is available on request.

## 15 - Linearity

Standard Independent linearity 3% LN3%  
Other Independent linearity below x%, for example, 4%: LN4% LNx%; ex: LN4%  
Absolute linearity controlled & below x% LAx%  
Other features could be available on request, please, ask.

## 16 - Potentiometers with assembled accessories

Assembled from terminal side WT  
Assembled from collector side WTI  
Accessory Reference -XXXXX Example: 14117  
See list of shafts and thumbwheels available  
Color of shaft or thumbwheel -YY Example, white: BA  
Non self-extinguishable. Self-extinguishable according to standard UL 94 (-V0 in box 17 modifies only the accessory, please, note.) (leave blank) -V0  
**For ordering spare accessories:** Accessory reference - color- flammability.  
Ex. 14117-AZ-V0 is a blue self-extinguishable 14117 thumbwheel XXXX-YY-V0

## Color chart for rotor, housing and accessories

Black <sup>(1)</sup>	White	Neutral	Transp.	Red	Green	Yellow	Blue	Grey	Brown
NE	BA	IN	TA	RO	VE	AM	AZ	GS	MR

(1) black is not an option for housings.

## Rotors

T is the standard rotor for RSR14. Rotors are drawn in their standard positioning, 50% of rotation. Alternative delivery positioning can be requested.

Accessories in this catalogue are designed for N, Z and T rotors, unless otherwise stated. Other rotor styles, on request.

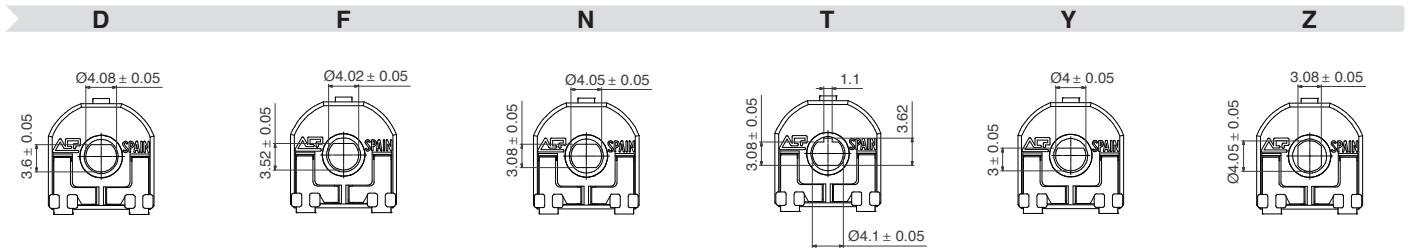

Standard color for F rotor is red

## Models

All models shown here have the most common rotor for RSR14, the T rotor.

### V15

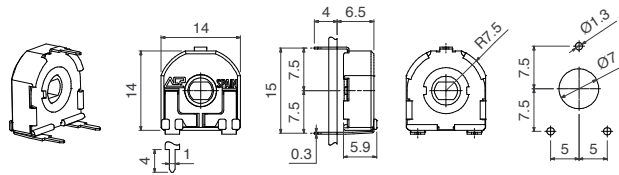

## Tapers

The standard taper is linear (A) and the standard ohm value is 10K, since a RSR14 will normally be used as a voltage divider. For other tapers, please, inquire.

### Voltage Divider

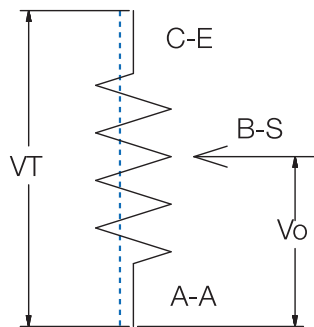

## Potentiometers with cut track

The cut track is an area with very high resistive value, resulting in an open circuit. It is widely used in lighting applications.

Mechanical life available with cut track needs to be confirmed case by case.

PCI = Cut at initial position, when the potentiometer is turned fully counter clockwise.

PCF = Cut at final position, when the potentiometer is turned fully clockwise.

Other positions are available on request.

### PCI

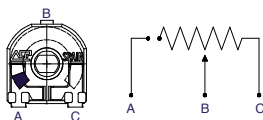

### PCF

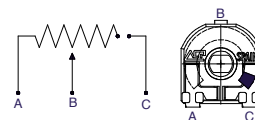

## Terminals

By default, terminals are always straight, as shown on the “models” section. ACP can provide crimped terminals (with snap in, “SNP”) to better hold the component to the PCB during the soldering operation.

### SNP

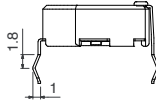

Shorter terminal tips are only available under request.

## Possibilities for insertion of accessories

Accessories can be mounted on potentiometers through either the front side (WT) or the collector side (WTI). For the specific angular position of shafts with planes, a drawing with the exact position is requested.

### WT Front side

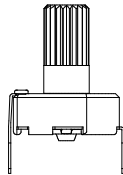

### WTI Collector side

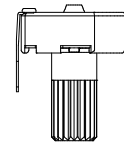

## Shafts

Shafts are available in different colors (color chart in “how to order” section) and with self-extinguishable property, according to UL 94 V-0, under request. ACP can study special shaft designs.

Shafts can be sold separately or delivered already mounted on the potentiometer at ACP.

When a shaft is mounted on a potentiometer, the distance from the top of the potentiometer to the top of the shaft is marked with “L” in the table below, as shown in the drawings:

### V potentiometer + shaft

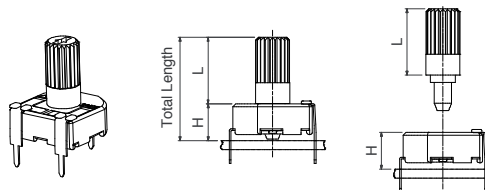

<b>Shaft</b>	14117	14081	14187	14251	14067	14084	14250	14072	14073
<b>L Dimension</b>	11.70	18.25	18.75	18.75	27.75	23.50	25.00	31.75	38.50

### 14067

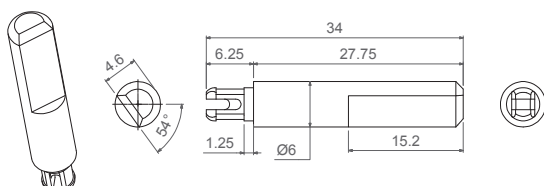

### 14072

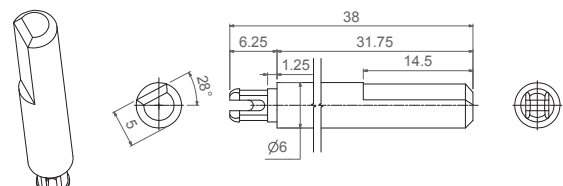

14073

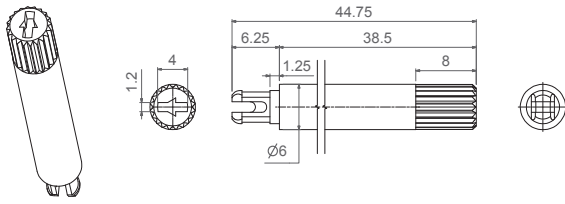

14081

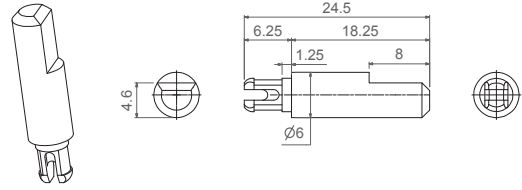

14084

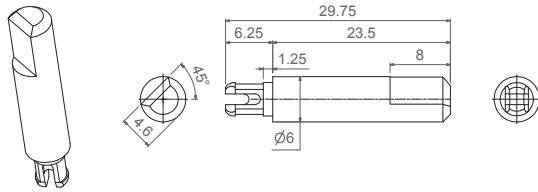

14117

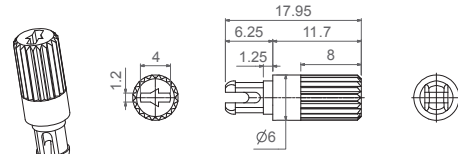

14187

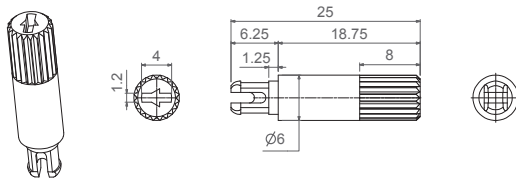

14250

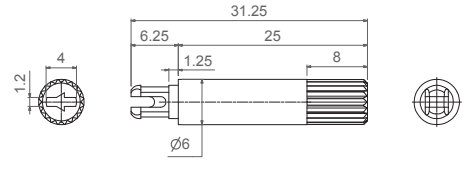

14251

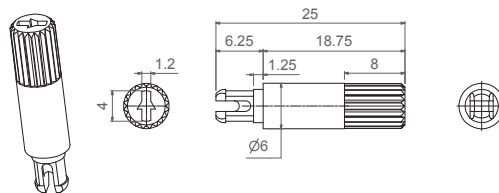



## Thumbwheel

Thumbwheels are available in different colors (color chart in “how to order” section) and with self-extinguishable property according to UL 94 V-0, under request.

Thumbwheels can be mounted on the potentiometers at ACP or sold separately. ACP can study special thumbwheel designs.

### 14003

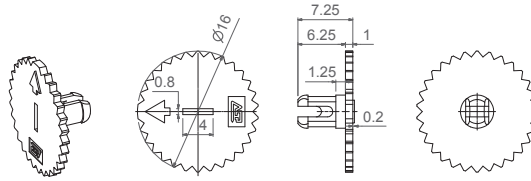

## Packaging

### Bulk packaging:

RSR14 model	With shaft or thumbwheel inserted?	Pieces per small box (150 x 100 x 70)	Pieces per bigger box (250 x 150 x 70, CG on description)
V15	None, only potentiometers.	200 150 for models with*	700
	14003, 14117	100	400 350 for models with*
	14067, 14072, 14073, 14081, 14084, 14187, 14250.	75	To be determined.

For models with \* and an inserted accessory, please, inquire about the quantity per box in that case.

## Electric Specifications

These are standard features; other specifications and out of range values can be studied on request.

### RSR14 Through-hole

Range of resistance values* Lin (A)	Standard value is 10K, as voltage divider use is supposed
Tolerance*	30%
Variation laws	Lin (A). Other tapers available on request
Residual resistance	Minimum value 2Ω
CRV - Contact Resistance Variation (dynamic)	Lin (A) Electrical Angle 245°±20° ≤ 3%Rn. Other tapers, please inquire
CRV - Contact Resistance Variation (static)	Lin (A) Electrical Angle 245°±20° ≤ 5%Rn. Other tapers, please inquire
Maximum power dissipation** Lin (A)	at 50°C, 0.15W
Maximum voltage Lin (A)	250VDC
Operating temperature	-25°C ... +85°C
Independent Linearity	3%
Temperature coefficient 100Ω ≤ Rn ≤ 10KΩ 10KΩ < Rn ≤ 5MΩ	+200/ -300 ppm +200/ -500 ppm

\* Out of range ohm values and tolerances are available on request, please, inquire.

\*\* Dissipation of special tapers will vary, please, inquire.

## Mechanical Specifications

### RSR14 Through-hole

Resistive element	Carbon technology
Angle of rotation (mechanical)	265° ± 5°
Angle of rotation (electrical)	245° ± 20°
Wiper standard delivery position	50% ± 15°
Max. stop torque	10 Ncm
Max. push/pull on rotor	50 N
Wiper torque*	<1.5 Ncm
Mechanical life	Standard: 100.000. 150.000 and 250.000 cycles. Up to 1.000.000 cycles (please, inquiry).

\* Stronger or softer torque feeling is available on request.

## Test results

The following typical test results (with 95% confidence) are given at 23°C ±2°C and 50% ±25% RH. Maximum linearity after mechanical tests: 4%.

### RSR14 Through-hole

	Test conditions	Typical variation of Rn
Damp heat	500 h. at 40°C and 95% RH	±20%
Temperature Coefficient	16 h at 85°C, plus 2 h at -25°C	±20%
Load life	1.000 h. at 50°C	±20%
Mechanical life	150.000 cycles at 10 c.p.m. and at 23°C ± 2°C	±20%
Storage (3 years)	3 years at 23°C ± 2°C	±3%

Power derating curve:

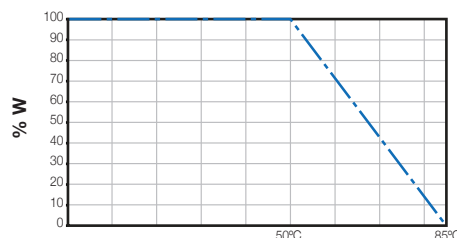

# CS14

Carbon Endless Sensor

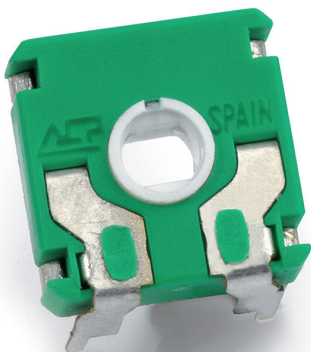
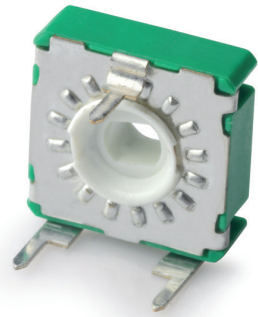



## CS14

14mm rotary position sensor with 360° mechanical rotation angle (electrical angle up to 330°).

Two configurations available:

- Standard, 15.000 turns, combinable with detents.
- Long life, up to 1 million turns.

Our 360° rotary sensor, CS14, can be manufactured in a wide range of possibilities regarding: resistance, tolerance, tapers, click effect (up to 50), positioning of the wiper, housing and rotor color.

Standard taper is linear. ACP can study other special tapers, (even cut tracks, step curves with areas of constant values, etc) as well as more strict linearity.

Through-hole and SMD configurations are available. Terminals and collector are manufactured in tinned brass although versions with steel terminals can be studied under request. Terminals for through-hole models can be provided straight and crimped, which helps hold the component to the PCB during soldering.

CS14 has plastic housing and Ingress Protection rating type IP 54 (high level protection against dust and also against water splashing), according to IEC 60529. Plastic materials can be self-extinguishable according to UL 94 V-0 under request.

Thumbwheels and shafts can be provided either separately or already inserted in the sensor.

### Applications

Control, function selector, position sensor for household appliances, automotive and industrial.

CS14 

# CS14 HOW TO ORDER

EXAMPLE: CS14NV15-10KA3030 LV15 RSN LN3% WT-14015-NE-V0

Standard features								Extra features							Assembled accessory			
Series	Rotor	Model	Packg.	Ohm value	Taper	Tol.	Life	Track	Detents	Snap in	Housing	Rotor	Wiper	Lin.	Assembly	Ref #	Color	Flam.
1	2	3	4	5	6	7	8	9	10	11	12	13	14	15	16			
CS14	N	V15		- 10K	A	3030	LV15					RSN		LN3%	WT	-14015	-NE	-V0

Standard configuration:	CS14 Through-hole	CS14 SMD
Dimensions:	14mm	
Protection:	IP 54 (dust-proof) On request: Self-extinguishable, to meet UL 94 V-0	
Substrate:	Carbon technology	Carbon technology, special for high temperature
Color:	Green housing + white rotor	Brown housing + grey rotor
Packaging:	Bulk	T & R
Wiper position:	at 50% ±15°	
Terminals:	Straight, without crimping.	J-Lead
Marking:	Resistive value marked on housing. Others on request.	

**Customized products:** A drawing is requested when ordering a customized product. Series, rotor, model and total resistive value are indicated before the code that includes all special specifications. Example: CS14NV15-10K CODE C00111.

## 1 - Series

■ CS14

## 2 - Rotors

B D\* E F\* G K M N\* P T\* X Y\* Z\*

\* Rotors available for versions with > 15.000 turns.

## 3 - Model and pitch

H0 H2,5 H5 V12,5 V15 V15...CFF VSMD VSMD...CY V12,5x5

4 - Packaging	Trough-hole	SMD models
Bulk	(blank)... <sup>(1)</sup>	(blank)... <sup>(1)</sup>
T&R (Tape and 13" reel)	(N.A.) <sup>(2)</sup>	T&R
T&R (Tape and 15" reel)	(N.A.) <sup>(2)</sup>	T&R15

Big Box: See page 9

(1) If blank, bulk packaging is implied. (2) N.A., Not Applicable: Tape and Reel packaging is only available for SMD terminals.

## 5 - Resistance value (see also page 10)

100Ω 200Ω 220Ω 250Ω 470Ω 500Ω 1KΩ 2KΩ ... 500KΩ 1MΩ 2MΩ 2M2Ω 4M7Ω 5MΩ

100 200 220 250 470 500 1K 2K 500K 1M 2M 2M2 4M7 5M

## 6 - Resistance law / taper (see also page 10)

Lin - Linear	A
Log - Logarithmic	B
Antilog - Antilogarithmic	C
- Special tapers have codes assigned:	CODE YXXXXX

## 7 - Tolerance (see also page 10)

±30%	+50%,-30%	±20%	±10%	±5%
3030	5030	2020	1010	0505

## 8 - Operating Life (Turns)

Standard (15.000 turns) (others on request). LV15

Long life: LV + number of turns. ex: LV100 for 100.000 turns, LV150, LV1M LVXXX: ex: LV100

## 9 - Cut Track - Open circuit

CS14 already has an open circuit area at the base of the potentiometer (between 330° and 0°). Additional cut tracks can be studied on request.

## 10 - Detents (DT) (Available for up to 15.000 turns) Standard 16 detents

X number of detents: ex. 16 detents XDT, ex: 16DT

Special detents are available on request: If you need to assign a voltage value to each detent, please inquire.

## 11 - Terminals (THT)

SNAP IN P	SNP
SNAP IN R	SNR
Shorter tip of terminal, TPXX, where XX is tip length (under request)	TPXX, ex: TP30
Steel Terminals	SH

## 12 - Housing

**Color:** For colors other than standard: -See color chart below- CJ-color, ex., red: CJ-RO

## 13 - Rotor

**Rotors N, T, Z** RSN

**All others rotors:** (leave blank)

**Color:** For colors other than standard: -See color chart below- RT-color; ex., blue: RT-AZ

## \* Self extinguishable property V0 for housing and rotor

Not V0 (by default) (leave blank)  
Housing and rotor V0 V0  
Only housing V0 CJ-V0  
Only rotor V0 RT-V0

## 14 - Wiper

**Wiper position** (Standard: 50% ± 15°) (leave blank)

Initial or CCW PI

Final or CW PF

Others: following clock positions. Ex at 3 hours: P3H PXH, ex: P3H

## Wiper torque

Standard for 15.000 turns: <2.5 Ncm, detents <3.5 Ncm (leave blank)

Special low torque for 15.000 turns <1.5 Ncm PGB

Standard for >15.000 turns <1.5 Ncm (leave blank)

Stronger or softer feeling than above, available on request.

## 15 - Linearity

Standard, according to IEC 190 (leave blank)

Independent linearity controlled and below x%. Ex: 3% LNx%, ex: LN3%

Absolute linearity controlled and below x%. Ex: 2,5% LAx%, ex: LA2,5%

## 16 - Potentiometers with assembled accessories

Assembled from terminal side WT

Assembled from collector side WTI

Accessory Reference -XXXXX ex: 14117

See list of shafts and thumbwheels available

Color of shaft or thumbwheel -YY ex: white: BA

Non self-extinguishable. Self-extinguishable according to standard UL 94 (-V0 in box 17 modifies only the accessory, please, note.) (leave blank) -V0

**For ordering spare accessories:** Accessory reference - color- flammability. Ex. 14117-AZ-V0 is a blue self-extinguishable 14117 thumbwheel XXXX-YY-V0

## Color chart for rotor, housing and accessories

Black <sup>(1)</sup>	White	Neutral	Transp.	Red	Green	Yellow	Blue	Grey	Brown
NE	BA	IN	TA	RO	VE	AM	AZ	GS	MR

(1) black is not an option for housings.

## Rotors

N is the standard rotor for CS14, but the following options are also available. Rotors are drawn in their standard positioning, 50% of rotation. Alternative delivery positioning can be requested. Accessories in this catalogue are designed for N, Z and T rotors, unless otherwise stated. Other rotor styles, on request.

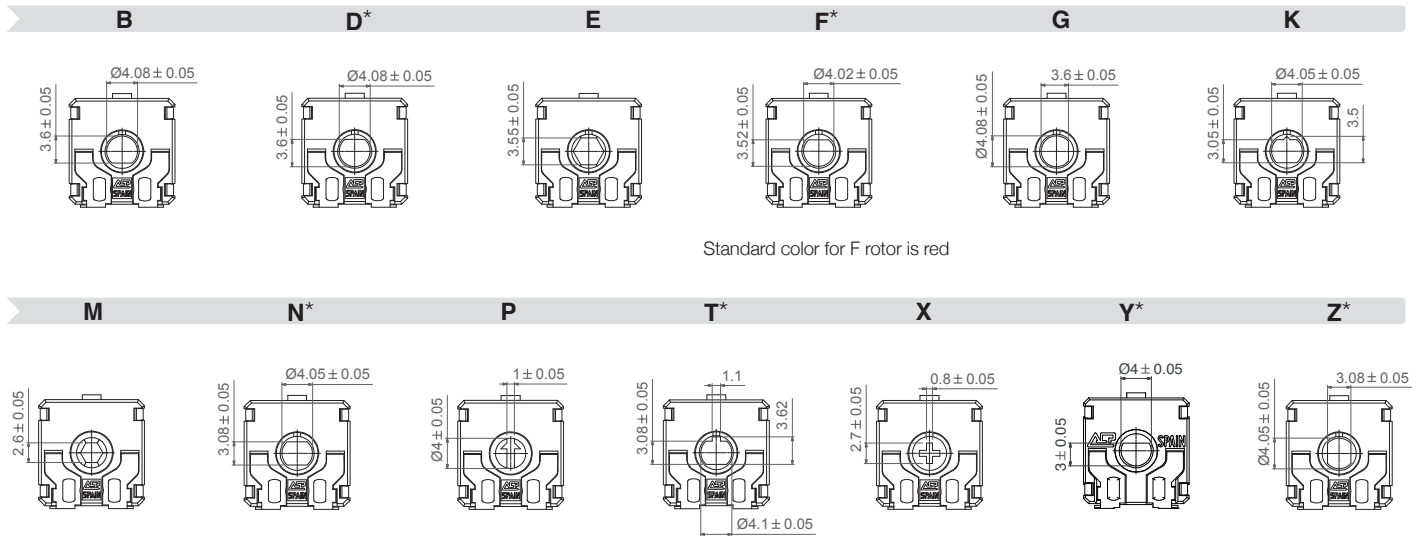

\*Please, note that for more than 15.000 turns (up to 1.000.000 turns) the following rotors are available: D, F, N, T, Y, Z.

## Models

H0, H2,5, H5, V12,5, V15, V15...CFF, V12,5x5, VSMD, VSMD...CY. For other models, such as those shown for the CA14, please inquire.

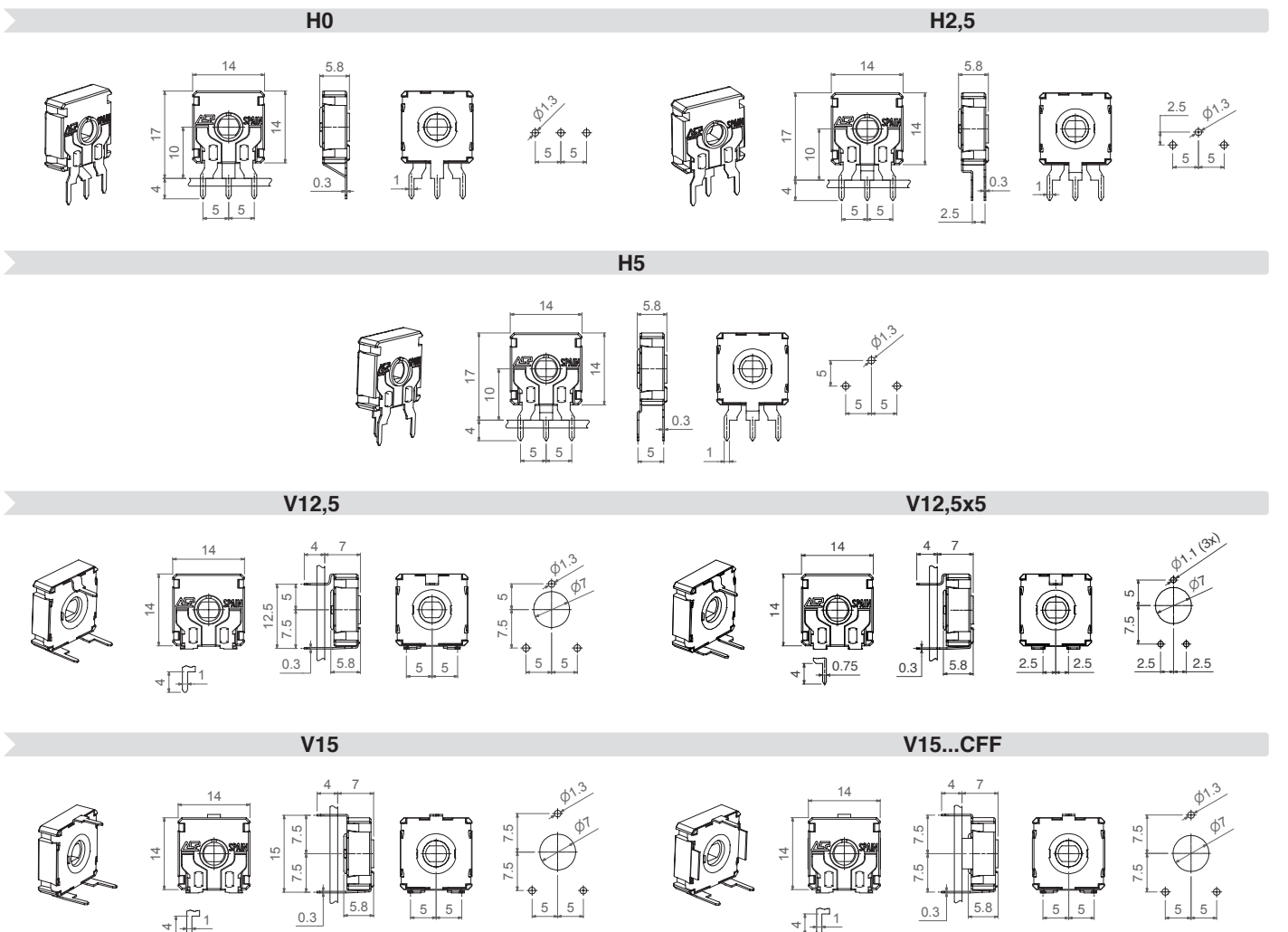

**VSMD**

**VSMD...CY**

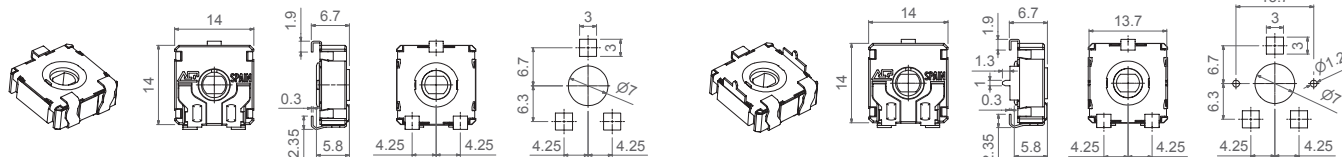

**LV 15**

**> LV 15**



Position indicating notch included on all LV15 rotors, except types M and P.

**Tapers**

The Standard taper is linear (A). Log (B) and Antilog (C) tapers are also available, as well as special tapers according to customer specifications. See an example on the application described on page 11.

**Potentiometers with detents**

ACP's patented detent (DT) feature is especially suitable for control applications where the end user will turn a knob inserted in the potentiometer. Detents can be used to add a click feeling to the turning of the potentiometer or to control the position in which the wiper is placed, assuring a particular output value with a narrow tolerance.

Detents can be light or strong, or even a combination of different feelings. They can be evenly distributed along the angle (standard) or tailored to match customers' request. They can also be combined with special tapers: constant value areas, open circuit zone, different slopes, etc. One common example is a potentiometer with detents and matching non-overlapping voltage values in specific angular positions, used to feed in a voltage value to a microprocessor.

Examples of some potentiometers with detents:

**16DT Standard**

**17DT (Max. non overlapping V)**

**50DT (Max. for feeling)**

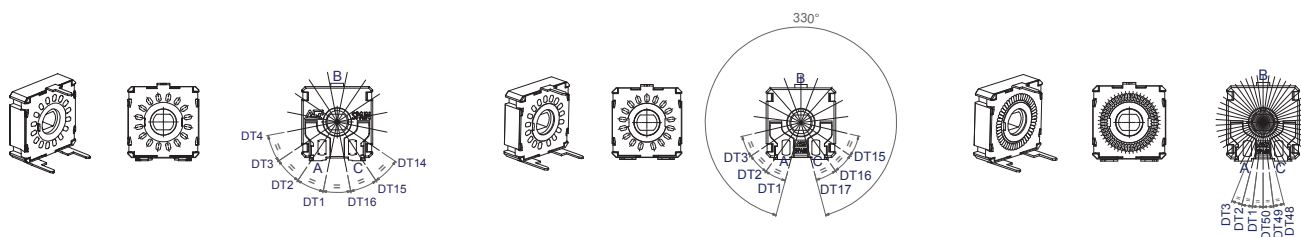

Our patented design with two wipers gives more stable electrical parameters, improved reliability and Contact Resistance Variation (CRV), as well as narrower tolerances for detent positioning.

For potentiometers with detents, mechanical life is also 15.000 turns if no additional turns are mentioned. Please, indicate the number of turns needed. When needing a special number of detents or matching taper, a drawing is kindly requested.

## Terminals

By default, terminals are always straight, as shown on the “models” section. ACP can provide crimped terminals (with snap in, “SNP” or “SNR”), to better hold the component to the PCB during the soldering operation.

### SNP

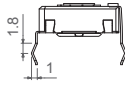

### SNR

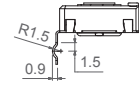

Also, there is an option of having shorter terminal tips.

### Standard Terminal

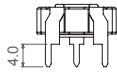

### Shorter terminal, TPXX (under request)

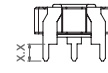

## Possibilities for insertion of accessories

Accessories can be mounted on potentiometers through either the front side (WT) or the metal collector side (WTI). For the specific angular position of shafts with planes, a drawing with the exact position is requested.

## Shafts

Shafts are available in different colors (color chart in “how to order” section) and with self-extinguishable property, according to UL 94 V-0, under request. ACP can study special shaft designs. Shafts can be sold separately or already mounted on the potentiometer. When a shaft is mounted on a potentiometer, the distance from the top of the potentiometer to the top of the shaft is marked with “L” in the table below, as shown in the drawing:

### H potentiometer + shaft

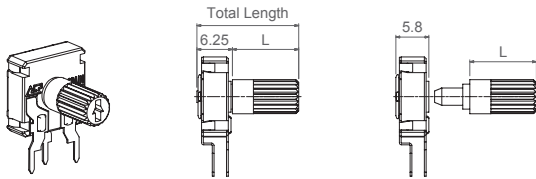

### V potentiometer + shaft

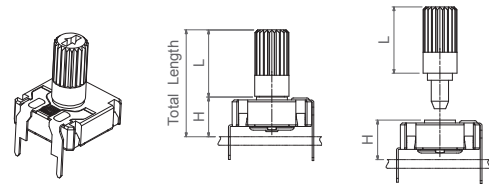

(H is set by the potentiometer model. See page 5)

Shaft	14042	14065 (For E rotor)	14117	14056	14081	14187	14251	14067	14008	14015	14066	14084	14250	14072	14073
L Dimension	7.05	11.50	11.70	12.25	18.25	18.75	18.75	27.75	23.25	23.25	23.50	23.50	25.00	31.75	38.50

### 14008

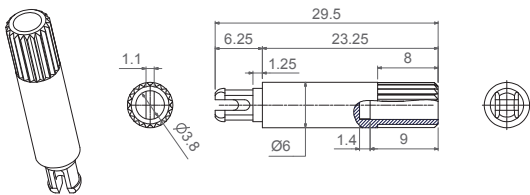

### 14015

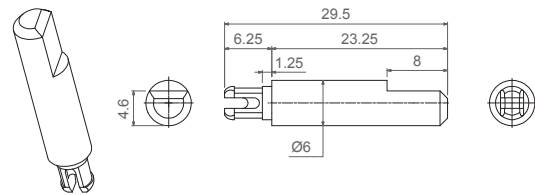

### 14042

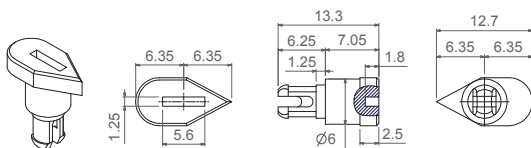

### 14056

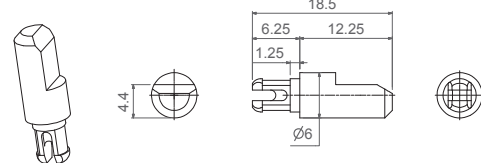

### 14065 (Designed for E rotor)

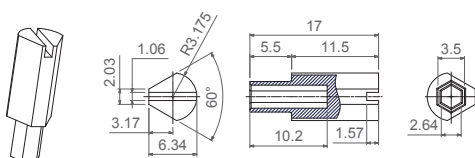

### 14066

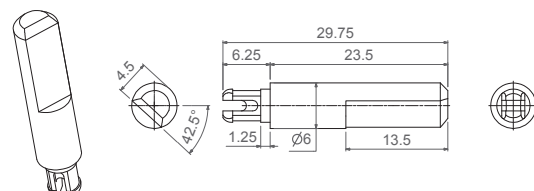



**Shafts**

**14067**

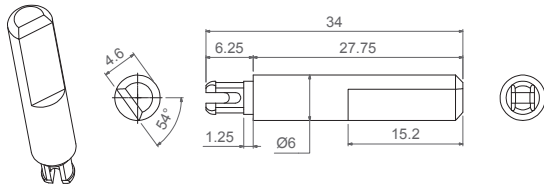

**14072**

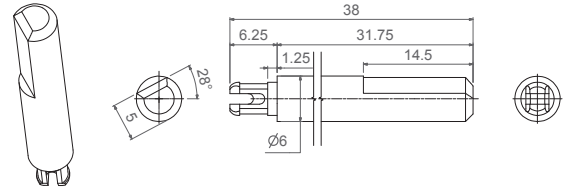

**14073**

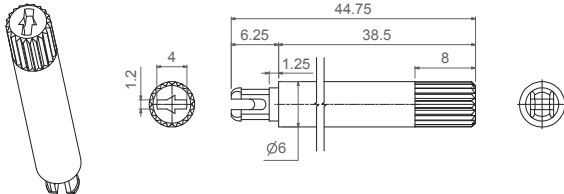

**14081**

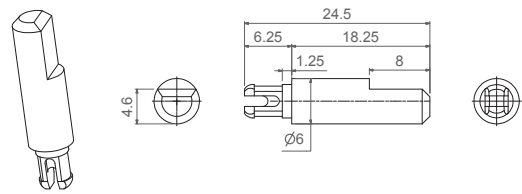

**14084**

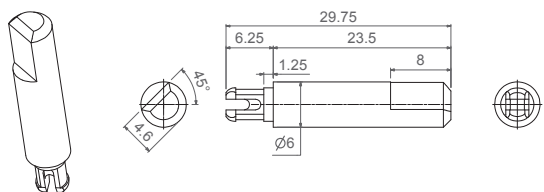

**14117**

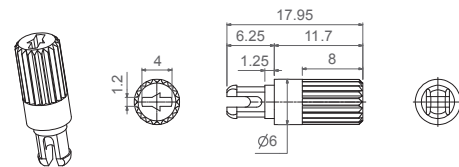

**14187**

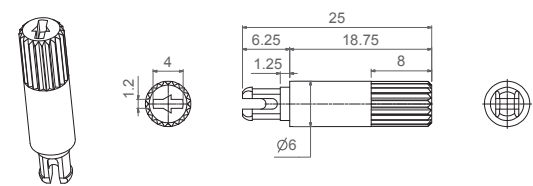

**14250**

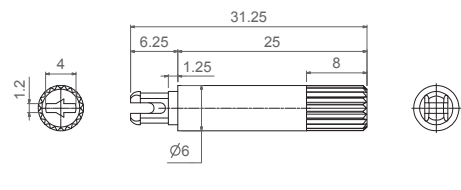

**14251**

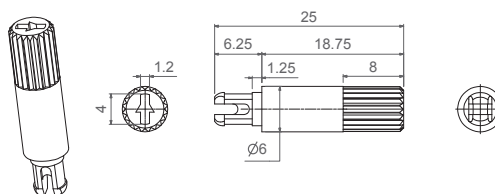

**Thumbwheel**

Thumbwheels are available in different colors (color chart in "how to order" section) and with self-extinguishable property according to UL 94 V-0, under request.

Thumbwheels can be mounted on the potentiometers at ACP or sold separately. ACP can study special thumbwheel designs.

**14003**

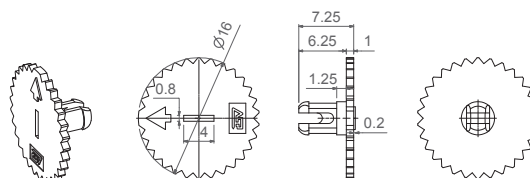

**Bulk packaging:**

CS14 model	With shaft or thumbwheel inserted?	Pieces per small box (150 x 100 x 70)	Pieces per bigger box (250 x 150 x 70) add CG at the end of the product description
H0 - H2,5 - H5 - V12,5 V12,5x5 - V15 V15CFF	None, only potentiometers.	200	700
	14003, 14117, 14042, 14056, 14065	100	400
	14008, 14015, 14066, 14067, 14072, 14073, 14081, 14084, 14187, 14250.	75	To be determined.

**Tape & Reel packaging:**

	With thumbwheel inserted?	13" Reel, with 24mm width tape	15" Reel, with 24mm width tape
VSMD (on request*)	None, only potentiometers.	500 pcs per reel, 16mm step between cavities.	800 pcs per reel, 16mm step between cavities.
	14003	450 pcs per reel, 16mm step between cavities.	To be determined.
VSMD...CY (on request*)	None, only potentiometers.	350 pcs per reel, 20mm step between cavities.	500 pcs per reel, 20mm step between cavities.
	14003	To be determined.	To be determined.

Sticker on component available on request.

**VSMD-T&R**

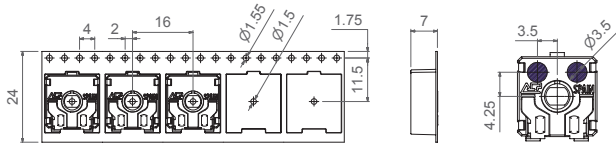

**VSMD-T&R...WT-14003**

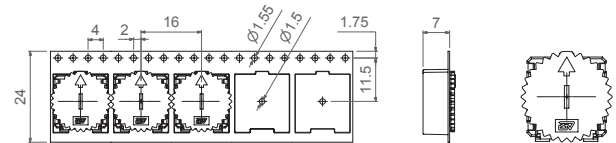

**VSMD-T&R...CY**

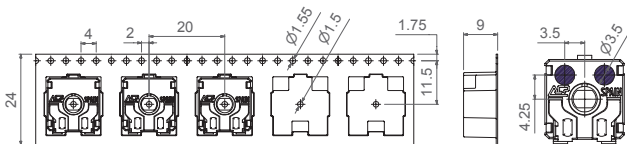

**VSMD-T&R...CY WT-14003**

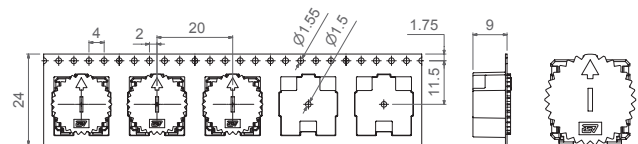

**13" Reel**

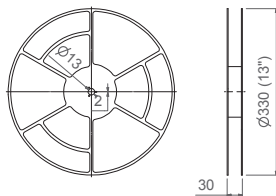

**15" Reel**

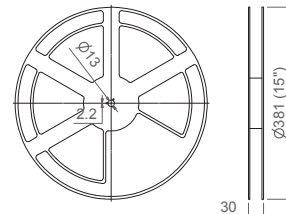

## Electric Specifications

These are standard features; other specifications and out of range values can be studied on request.

	CS14 Through-hole	CS14 SMD (upon availability)
Range of resistance values* Lin (A) Log (B) Antilog (C)	100Ω ≤ Rn ≤ 5MΩ 1 KΩ ≤ Rn ≤ 2M2Ω	100Ω ≤ Rn ≤ 1MΩ 1 KΩ ≤ Rn ≤ 1 MΩ
Tolerance* (Please, inquire for >100K turns) 100Ω ≤ Rn ≤ 100KΩ 100KΩ < Rn ≤ 1MΩ: 1MΩ < Rn ≤ 5MΩ: Rn > 5MΩ:	±30% ±30% ±30% +50%, -30% (out of range)	- ±30% ±40% ±50% -
Variation laws	Lin (A). Other tapers available on request	
CRV - Contact Resistance Variation (dynamic)	Lin (A) Electrical Angle 330°±20° ≤ 3%Rn. Other tapers, please inquire	
CRV - Contact Resistance Variation (static)	Lin (A) Electrical Angle 330°±20° ≤ 5%Rn. Other tapers, please inquire	
Maximum power dissipation** Lin (A)	at 50°C, 0.15W	
Maximum voltage Lin (A)	250VDC	
Operating temperature	-25°C ... +70°C (+85°C on request) Special Version 120° C	
Angle of rotation (electrical)	330° ± 20°	
Temperature coefficient 100Ω ≤ Rn ≤ 10KΩ 10KΩ < Rn ≤ 5MΩ	+200/ -300 ppm +200/ -500 ppm	+200/ -500 ppm +200/ -1000 ppm

\* Out of range ohm values and tolerances are available on request, please, inquire.

\*\* Dissipation of special tapers will vary, please, inquire.

## Mechanical Specifications

### CS14 Through-hole and SMD

Resistive element	Carbon technology
Angle of rotation (mechanical)	360°
Wiper standard delivery position	50% ± 15°
Max. push/pull on rotor	35 N / 50 N
Wiper torque*	For 15.000 turns <2.5 Ncm, detents <3.5 Ncm For >15.000 turns <1.5Ncm
Mechanical life	Standard is 15.000 turns. Up to 1.000.000 turns available depending on configuration

\* Stronger or softer torque feeling is available on request.

## Test results

The following typical test results (with 95% confidence) are given at 23°C ±2°C and 50% ±25% RH.

### CS14 Through-hole and SMD

	Test conditions	Typical variation of Rn
Damp heat	500 h. at 40°C and 95% RH	±20%
Temperature Coefficient	16 h at 85°C, plus 2 h at -25°C	±20%
Load life	1.000 h. at 50°C	±20%
Mechanical life	15.000 turns at 10 c.p.m. and at 23°C ± 2°C	±20%
Storage (3 years)	3 years at 23°C ± 2°C	±3%

**CS14 as alternative to a 4 bit absolute encoder. Linear curve.**

A combination of a controlled linear curve and mechanical detents distributed along the 360° of the endless turn CS14 is an alternative to a 4-bit absolute encoder

Using the CS14 as a voltage divider, we can obtain 16 non-overlapping voltage values at each one of the 16 detents located evenly spread along the full circumference with a separation of 22.5° between each contiguous detent. See figure 1.

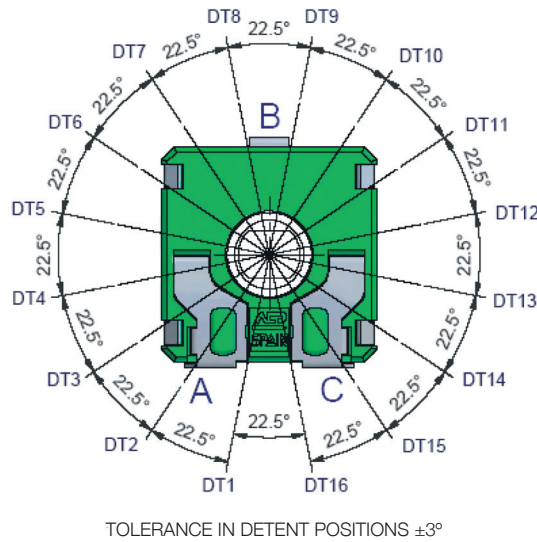

Figure 1

The graph of the linear curve that provides this performance is in the figure 2. We call it the curve FP and it makes possible to differentiate 16 non-overlapping different voltage levels from the collector output pin. (B in figure 1)

The function of the detents is to position and fix the wiper contact on the surface of the linear taper. An electrical control of each one of the 16 detents of each individual potentiometer during the assembly process ensures that the voltage levels are correct in each one of them.

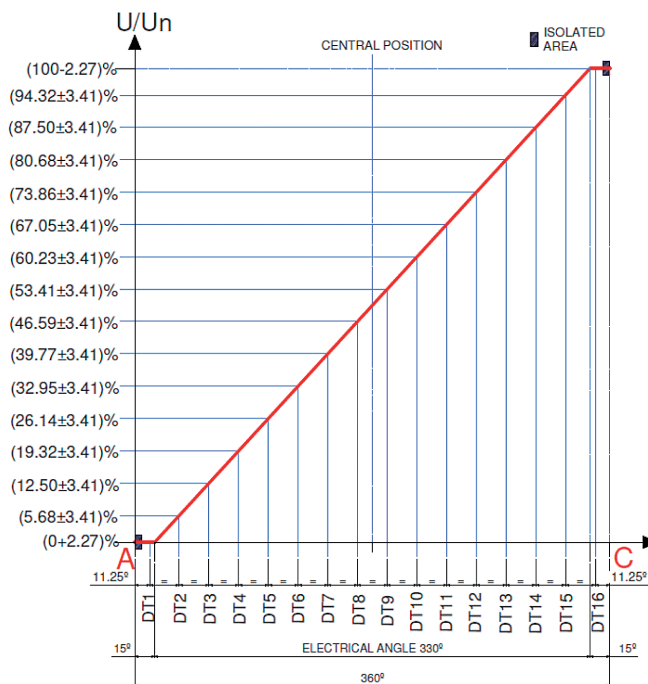

Figure 2  
Curve FP

The endless rotation feature of the CS14 allows to move from the detent number 16 ( $U/U_n = 100\%$ ) to the detent number 1 ( $U/U_n = 0\%$ ). During the transition between these two detents, the wiper will slide on a dead zone for a few degrees, meaning that at that moment there will be no electrical contact with the resistive track.

In order to cope with this we recommend either to introduce a pull-up or pull-down resistor into the circuit design. ACP proposes the latter, a pull-down resistor whose value has to be at least 100 times the potentiometer nominal value. In that case, the collector pin output will be 0% ( $U/U_n$ ) when the slider transits on the dead zone.

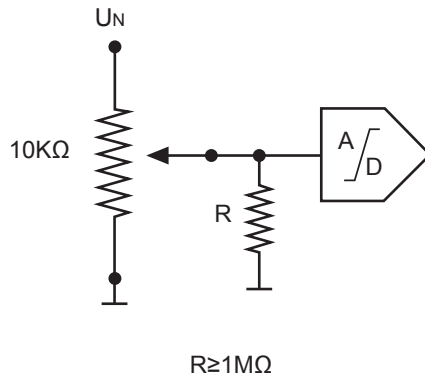

Figure 3

ACP standard configuration is a potentiometer of 10K Ohm and a recommended pull-down resistor equal or greater than 1MΩ. (Figure 3). The mechanical life is 15.000 turns.

Connecting the collector terminal to the AD port of a microcontroller to feed into it the output voltage of such a configuration will allow for the selection of 16 different functions.

The table below (figure 4) shows the equivalence between the output function of this potentiometer, indicating the tolerance at each detent, and a 4-bit digital encoder signal.

An example of How to Order would be CS14NV15-10KFP3030 LV15 16DT RSN. Note that it is not necessary to indicate the linearity, as it is already implicit in the curve FP.

Detent	U/UN	Decimal	Hexadecimal	Binary	Octal
1	(0+2,27)%	0	0	0000	0
2	(5,68±3,41)%	1	1	0001	1
3	(12,50±3,41)%	2	2	0010	2
4	(19,32±3,41)%	3	3	0011	3
5	(26,14±3,41)%	4	4	0100	4
6	(32,95±3,41)%	5	5	0101	5
7	(39,77±3,41)%	6	6	0110	6
8	(46,59±3,41)%	7	7	0111	7
9	(53,41±3,41)%	8	8	1000	10
10	(60,23±3,41)%	9	9	1001	11
11	(67,05±3,41)%	10	A	1010	12
12	(73,86±3,41)%	11	B	1011	13
13	(80,68±3,41)%	12	C	1100	14
14	(87,50±3,41)%	13	D	1101	15
15	(94,32±3,41)%	14	E	1110	16
16	(100-2,27)%	15	F	1111	17

Figure 4



## Q16

Rotary Potentiometer Switch

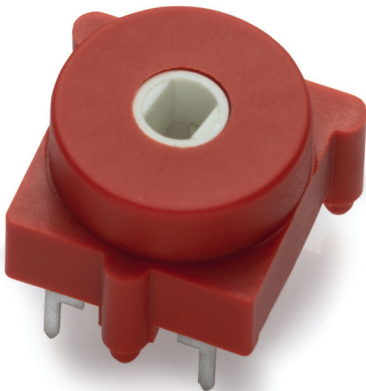
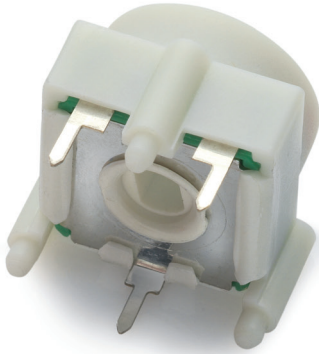

## Q16

Q16 is a particular application of the CS14 product family when robust and precise detents are required. This ACP patented design consists of a 16x15mm. rectangular shape external housing with a built-in detent mechanism, fitted on a CS14 V potentiometer.

The standard configuration has 16 detents evenly distributed along its 360° endless rotation, and allows to choose between 4 different detent torque values, from 3 Ncm to 6 Ncm to provide different degrees of softer or harder feeling.

The linear characteristics and materials of the CS14 core potentiometer, combined with the detent mechanism, guarantee at least 10.000 turns and no voltage overlapping between contiguous positions.

The rotor design allows a thru shaft to be inserted into the rotor from either top or below side. A Poka-Yoke feature incorporated in the rotor avoids shaft misplacement.

This Rotary Potentiometer Switch is the ideal alternative to Absolute Encoders and Rotary Switches for control applications like Program Selector Switches in White Goods: Washing Machines, Dishwashers, Dryers, Electrical Ovens etc., Controls in other Appliances like Ranges, Microwave Ovens, Kitchen Robots, etc., and HVAC in Automotive: Air Flow Distribution Switch, Temperature Setting and Fan Speed Selection.

Ingress Protection rating type is IP54 and plastic materials can be self-extinguishable according to UL 94V0 whenever required.

# Q16 HOW TO ORDER

EXAMPLE: Q16RV15 10KA3030 LV10 16DT 3N PDT1

## Standard features

Series	Rotor	Model	Packaging	Ohm value	Taper	Tolerance	Life	N° Detents	Det.torque.	Terminals	Flammability	Position
1	2	3	4	5	6	7	8	9	10	11	12	13
Q16	R	V15		10K	A	3030	LV10	16DT	3N			PDT1

## Standard configuration:

## Q16

Dimensions:	16x15mm
Protection:	IP 54. On request: Self extinguishable, to meet UL 94 V0
Core potentiometer:	CS14
Packaging:	Bulk
Wiper position:	Detent 1 (PDT1)
Terminals:	Straight
Marking:	Resistive value marked on housing. Others on request.

### 1 - Series

■ Q16

### 2 - Rotors

R Standard. (Others under study).

### 3 - Model and pitch

V15 Standard. VSMD under study.

### 4 - Packaging

Bulk (blank)...<sup>(1)</sup>

<sup>(1)</sup> Products supplied bulk packed in bags, unless otherwise specified.

### 5 - Resistive value

100Ω	200Ω	220Ω	250Ω	470Ω	500Ω	1KΩ	10KΩ standard...	5MΩ
100	200	220	250	470	500	1K	10K	5M

### 6 - Taper

Lin - Linear A

Others under study. Code will be assigned case by case.

### 7 - Tolerance

100 Ω ≤ Rn ≤ 100KΩ:	100 KΩ < Rn ≤ 1MΩ:	1 MΩ < Rn ≤ 5MΩ:
±30%	±30%	+50%,-30%
3030	3030	5030

Special tolerances under request. Please check availability.

### 8 - Operating Life (Turns)

Standard (10.000 turns) (others on request).	LV10
Long life: LV + number of turns. (please inquire availability).	LVXXX: ex: LV20

### 9 - Numbers of detents

Standard: 16 detents.	16DT
Other configurations under study	

### 10 - Detent torque

Standard: 3 Ncm	3N
Others available 4Ncm, 5Ncm, 6Ncm	4N, 5N, 6N

### 11 - Terminals

By default, terminals are always straight	(leave blank)
SNAP IN P	SNP
Steel Terminals	SH

### 12 - Flammability

Standard: Non self extinguishable.	(leave blank)
All housings and rotors self extinguishable according to UL 94 V0.	V0
Only Q16 housing and rotor self extinguishable V0	Q-V0

### 13 - Delivery position

Standard, position at detent 1	PDT1
Position at detent. XX= (position number)	PDTXX

### Special marking

Special marking	GRE
-----------------	-----

## Rotor

R is the standard rotor for Q16. Other options can be made under study.

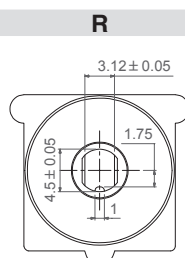

This drawing shows the rotor at 50% position in order to better depict the dimensions and tolerances, it is not a valid delivery option of the 16 position version.



V15 is the standard model.

V15

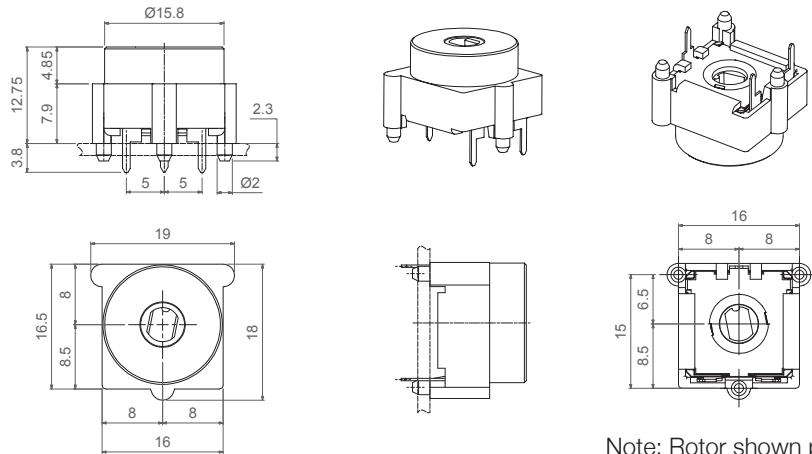

Note: Rotor shown positioned at detent 1 (PDT1)

Tapers

The CS14 core potentiometer has a linear taper that provides the voltage ratios indicated at each detent shown in the graph. Non overlapping voltage between contiguous positions is guaranteed.

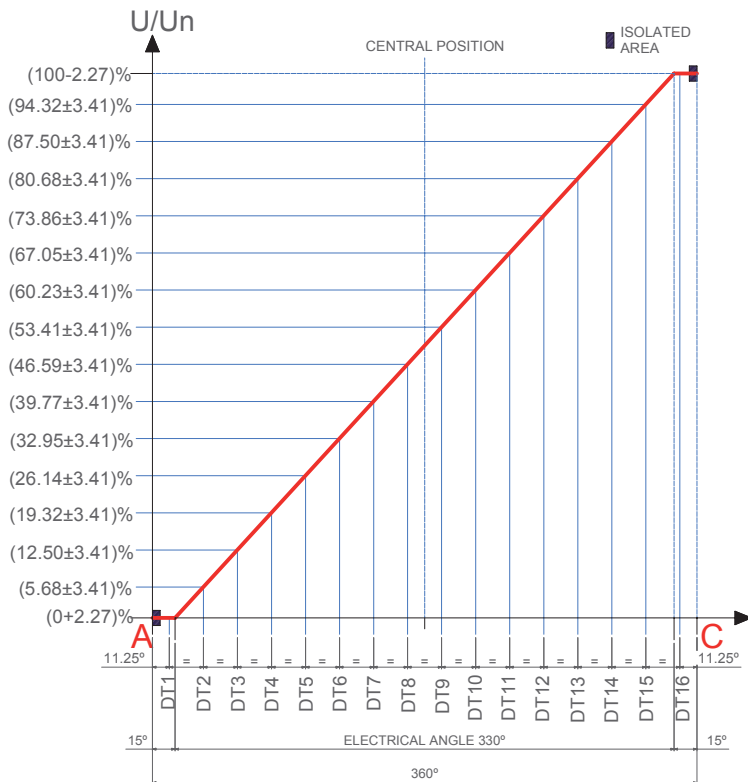

DETENT	VALUE
1	(0+2.27)% Un
2	(5.68±3.41)% Un
3	(12.50±3.41)% Un
4	(19.32±3.41)% Un
5	(26.14±3.41)% Un
6	(32.95±3.41)% Un
7	(39.77±3.41)% Un
8	(46.59±3.41)% Un
9	(53.41±3.41)% Un
10	(60.23±3.41)% Un
11	(67.05±3.41)% Un
12	(73.86±3.41)% Un
13	(80.68±3.41)% Un
14	(87.50±3.41)% Un
15	(94.32±3.41)% Un
16	(100-2.27)% Un

Detents/ Torque

Conceived specifically for control applications where robust click feeling is required along the full circumference. The Q16 incorporates an ACP patented design that provides 4 possible different torque levels: 3Ncm, 4Ncm, 5Ncm or 6Ncm, upon customer's choice, with a mechanical life of at least 10.000 turns.

The standard number of detents is 16, all of them evenly spread along the 360° mechanical travel, an ideal configuration for 16 function selection in White Goods.

Tailor made configurations with different number of detents, preferably even numbers equally spread along the 360°, can be studied on request. Other mechanical life requirements are also possible upon study.

16DT

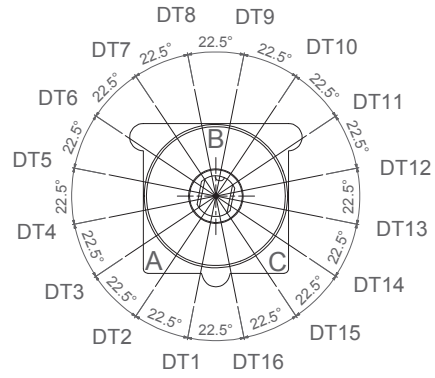
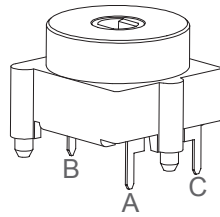

**Delivery Position**

Unless otherwise specified, the Q16 is delivered with the wiper on position 1 (PDT1).

**Shafts**

Shafts are sold separately. They can be inserted from either top or below side. Please consult ACP for studying special designs. Rotor inner dimensions shown for customer's own shaft design.

**Rotor inner dimensions**

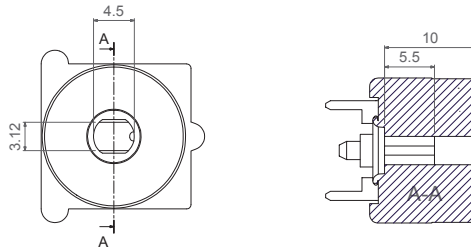

This drawing shows the rotor at 50% position in order to better depict the dimensions and tolerances, it is not a valid delivery option of the 16 position version.

**14301**

**14315**

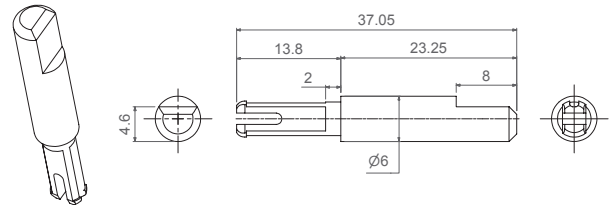
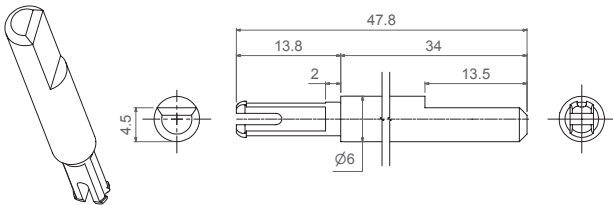

**Packaging**

**Bulk packaging:**

**Pieces per box (250 x 150 x 70)**

Q16 model

200

**Electrical Specifications**

(See CS14 Through Hole table on page 66).

**Mechanical Specifications**

**Test results**

Resistive element	Carbon
Angle of rotation (mechanical)	360°
Wiper standard delivery position	Detent 1 (PDT1)
Max. push/pull on rotor	50N
Wiper torque*	From 3N to 6N depending on customer choice.
Mechanical life	At least 10.000 turns.

Damp heat	(See CS14 table on page 66)
Temperature Coefficient	
Load life	
Mechanical life	
Storage (3 years)	

# QJ16

Spring Loaded Potentiometer

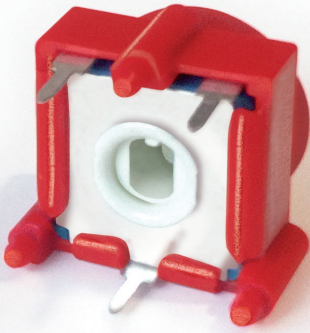

## QJ16

ACP Q16 series expands its range with the launching of the new spring loaded potentiometer version called QJ16.

Keeping the same dimensions and layout of the Q16, the functionality is completely different. When the operator turns the knob CW or CCW from the central rest position, a spring mechanism fitted into the component provides an opposite torque. When releasing the knob, the spring returns the potentiometer to the central rest position.

Electrically, the potentiometer is a standard 245° linear taper with a 5% absolute linearity. The mechanical rest position corresponds to the physical middle position, hence to the central value of the output signal. Starting from there, the output value varies along the linear curve until reaching the corresponding end stop.

An alternative output signal to the above is an SPDT (Single Pole, Double Throw) configuration, with “on” positions at both mechanical end stops and “off” position in the central rest position. Mechanical angle option available is  $\pm 45^\circ$ .

### **Application:**

This Spring Loaded potentiometer is the ideal alternative to a tact switch or incremental encoder to increase or decrease the value of a certain parameter.

# QJ16 HOW TO ORDER

EXAMPLE: QJ16RV15 10KA3030 LV10

## Standard features

Series	Rotor	Model	Packaging	Ohm value	Taper	Tolerance	Life	Mechanical Angle	Terminals	Flammability	Position
1	2	3	4	5	6	7	8	9	10	11	12
QJ16	R	V15		10K	A	3030	LV10	±45°			

## Standard configuration:

## QJ16

Dimensions:	16x15mm
Protection:	IP 54. On request: Self extinguishable, to meet UL 94 V0
Core potentiometer:	CA14 // RS14
Packaging:	Bulk A
Wiper position:	Middle position
Terminals:	Straight
Marking:	Resistive value marked on housing. Others on request.

### 1 - Series

■ QJ16

### 2 - Rotors

R Standard. (Others under study).

### 3 - Model and pitch

V15 Standard. VSMD under study.

### 4 - Packaging

Bulk (blank)...<sup>(1)</sup>

<sup>(1)</sup> Products supplied bulk packed in bags, unless otherwise specified.

### 5 - Resistive value

100Ω	200Ω	220Ω	250Ω	470Ω	500Ω	1KΩ	10KΩ standard...	5MΩ
100	200	220	250	470	500	1K	<b>10K</b>	5M

### 6 - Taper

Lin - Linear A

Others under study. Code will be assigned case by case.

### 7 - Tolerance

100Ω ≤ Rn ≤ 100KΩ:	100KΩ ≤ Rn ≤ 1MΩ:	1MΩ ≤ Rn ≤ 5MΩ:
±30%	±30%	+50%, -30%
3030	3030	5030

Special tolerances under request. Please check availability.

### 8 - Operating Life (Turns)

Standard (10.000 cycles) LV10

Long life: LV + number of cycles. (please inquire availability). LVXXX: ex: LV20

### 9 - Mechanical Angle

Standard ±45° (leave blank)

Other configurations under study

### 10 - Terminals

By default, terminals are always straight (leave blank)

SNAP IN P SNP

Steel Terminals SH

### 11 - Flammability

Standard: Non self extinguishable. (leave blank)

All housings and rotors self extinguishable according to UL 94 V0. V0

Only QJ16 housing and rotor self extinguishable V0 Q-V0

### 12 - Delivery position

Standard, middle position (leave blank)

### Special marking

Special marking GRE

## Rotor

R is the standard rotor for QJ16. Other options can be made under study.

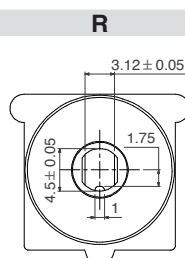

This drawing shows the rotor at 50% position, which is the standard delivery position.

## Models

V15 is the standard model.

### V15

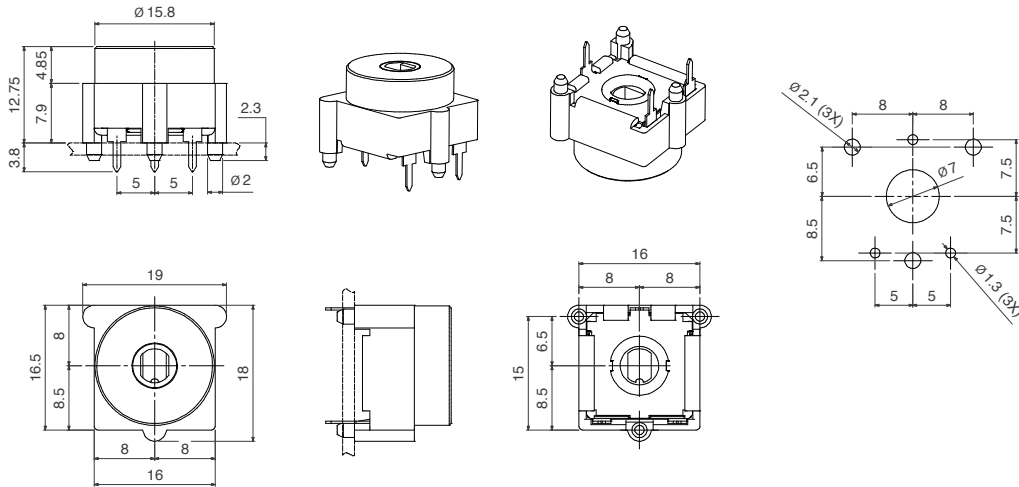

## Tapers

The core potentiometer is a standard 245° linear taper with a 5% absolute linearity. The mechanical rest position corresponds to the physical middle position, hence to the central value of the output signal. Starting from there, the output value varies along the linear curve until reaching the corresponding end stop.

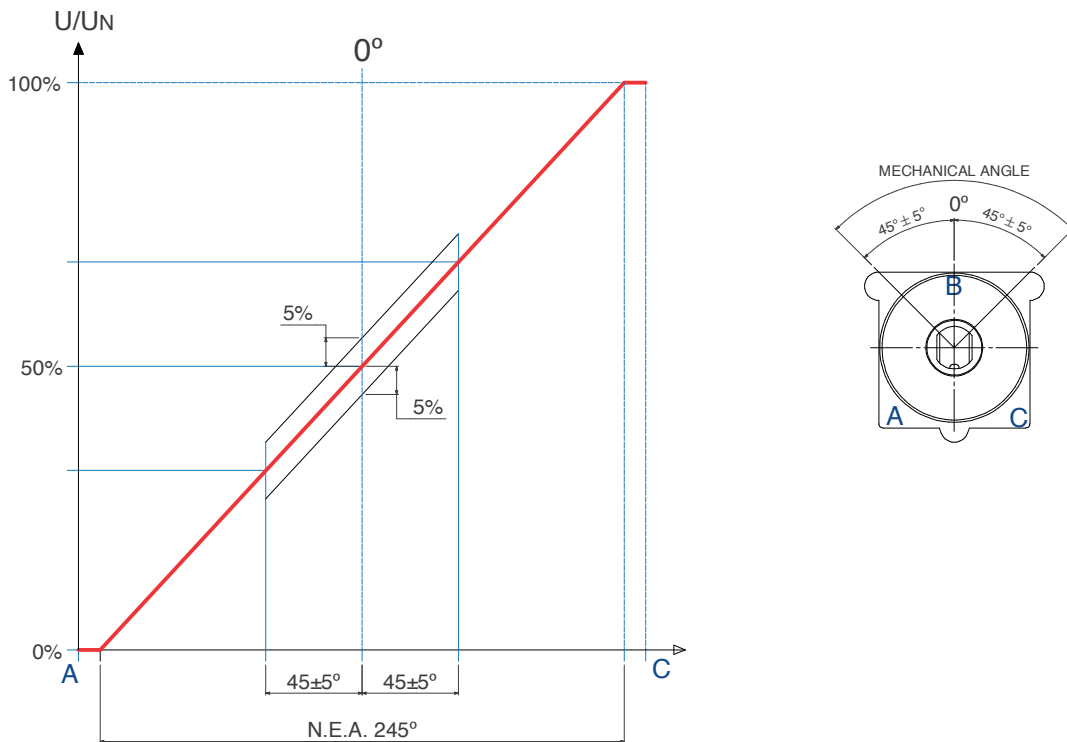

An alternative output signal to the above is an SPDT\* configuration, with “on” positions at both mechanical end stops and “off” position in the central rest position. Mechanical angle option available:  $\pm 45^\circ$

\*Single pole, double throw. A simple break-before-make changeover switch: C (COM, Common) is connected either to L1 or to L2

## Delivery Position

The QJ16 is delivered with the wiper on middle position.

## Shafts

Shafts are sold separately. They can be inserted from either top or below side.  
Please consult ACP for studying special designs.  
Rotor inner dimensions shown for customer's own shaft design.

### Rotor inner dimensions

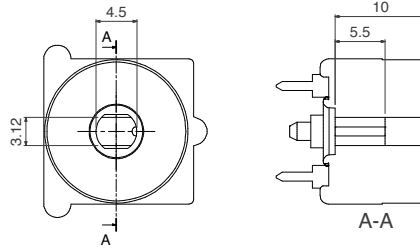

This drawing shows the rotor at 50% position, which is the standard delivery position

### 14301

### 14315

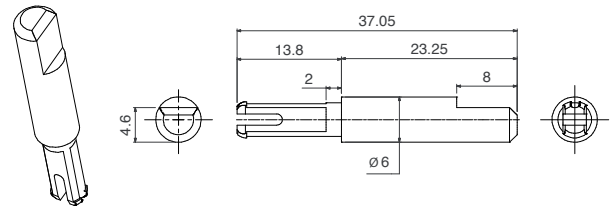
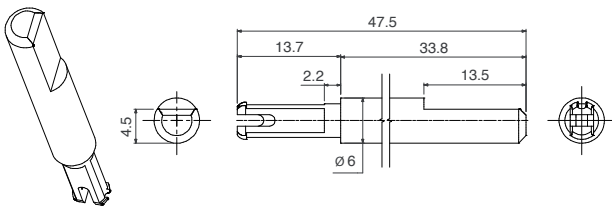

## Packaging

### Bulk packaging:

### Pieces per box (250 x 150 x 70)

QJ16 model

200

## Electrical Specifications

Range of resistance values*	Standard value is 10k
Tolerance	±30%
Variation laws	Lin (A). Other tapers available on request
CRV - Contact Resistance Variation (dynamic)	Lin (A) Electrical Angle $245^{\circ} \pm 20^{\circ} \leq 3\%R_n$ . Other tapers, please inquire
CRV - Contact Resistance Variation (static)	Lin (A) Electrical Angle $245^{\circ} \pm 20^{\circ} \leq 5\%R_n$ . Other tapers, please inquire
Maximum power dissipation**	at 50°C, 0.15W
Maximum voltage	250VDC
Operating temperature	-25°C ... +70°C (Other under request)
Electrical angle	$245^{\circ} \pm 20^{\circ}$
Linearity	5%
Temperature coefficient	+200/ -300 ppm

## Mechanical Specifications

Resistive element	Carbon technology
Angle of rotation (mechanical)	$\pm 45^{\circ} \pm 5^{\circ}$
Wiper standard delivery position	Neutral position $\pm 5^{\circ}$
Max. stop torque	50Ncm
Max. push/pull on rotor	50N
Wiper torque*	0,5-3,5Ncm
Mechanical life	10.000 cycles.

\* Out of range ohm values and tolerances are available on request, please, inquire.

\*\* Dissipation of special tapers will vary, please, inquire.

## Test results

The following typical test results (with 95% confidence) are given at  $23^{\circ}\text{C} \pm 2^{\circ}\text{C}$  and  $50\% \pm 25\% \text{RH}$ .

	Test conditions	Typical variation of $R_n$	Linearity after test
Damp heat	500 h. at $40^{\circ}\text{C}$ and 95% RH	±20%	7%
Thermal cycles	16 h at $85^{\circ}\text{C}$ , plus 2 h at $-25^{\circ}\text{C}$	±20%	7%
Load life	1.000 h. at $50^{\circ}\text{C}$	±20%	7%
Mechanical life	10.000 cycles at 10 c.p.m. and at $23^{\circ}\text{C} \pm 2^{\circ}\text{C}$	±20%	7%
Storage (3 years)	3 years at $23^{\circ}\text{C} \pm 2^{\circ}\text{C}$	±3%	7%

**MCA9**   
Control Carbon  
Potentiometers MCA

**MCE9**   
Control Cermet  
Potentiometers MCE

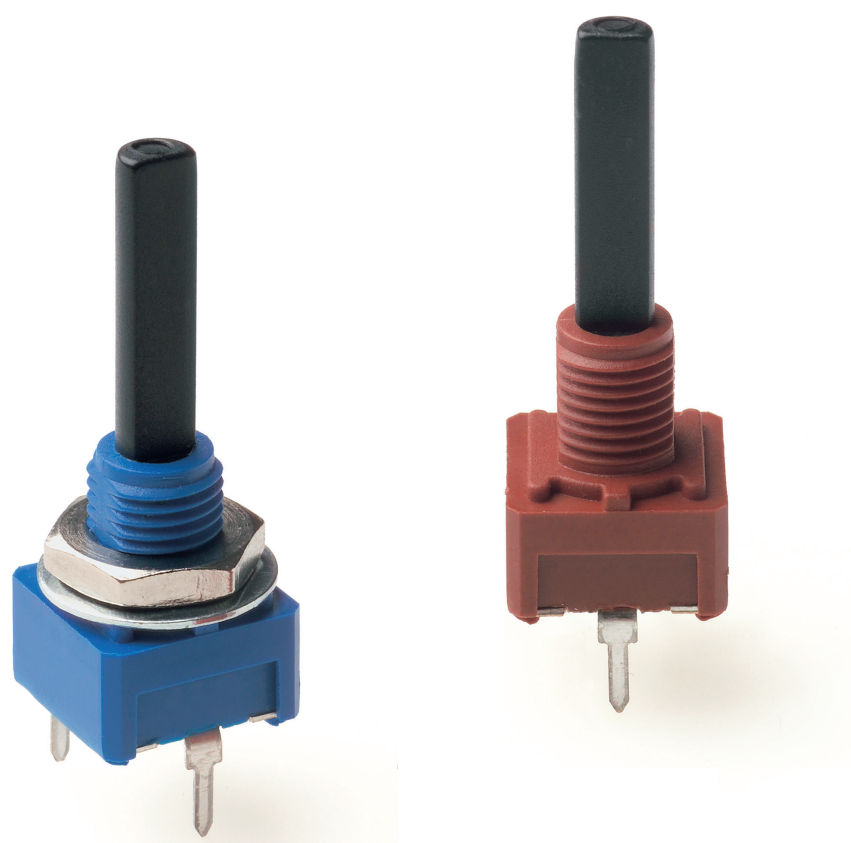

## CARBON – MCA9

9mm carbon potentiometers with plastic enclosure and shaft.

Through-hole and SMD configurations are available. Terminals and collector are normally manufactured in tinned brass, although versions with steel terminals are also available under request. Terminals for through-hole models can be provided straight or crimped, which helps hold the component to the PCB during soldering.

Ingress Protection rating type IP 54 (high level of protection against dust and also against water splashing), according to IEC 60529. Plastic materials can be self-extinguishable according to UL 94 V-0 under request.

Tapers can be linear, log and antilog; special tapers can also be studied.

Potentiometers can be manufactured in a wide range of possibilities regarding:

- Resistance value.
- Tolerance.
- Tapers / variation laws.
- Pitch.
- Positioning of the wiper (standard is at 50% rotation).
- Housing and rotor color.
- Mechanical life.
- Click effect (up to 20 detents available).
- Self-extinguishable plastic parts, according to UL 94 V-0.

### Applications

9mm potentiometers are mainly used in control applications, in different markets:

- Industrial: Timers and relays, dimmers, adjustment of output.
- Electronic appliances: volume regulation, temperature controls and function selection.
- Automotive: Lighting regulation (position adjustment and sensing for headlights), dimmers, seat heating controls.

## CERMET – MCE9

9mm cermet potentiometers with plastic enclosure and shaft. Cermet potentiometers have better thermal stability, allow for higher thermal dissipation and withstand higher temperatures than carbon potentiometers.

Through-hole and SMD configurations are available. Terminals and collector are manufactured in tinned brass, although versions with steel terminals are also available under request. Terminals for through-hole models can be provided straight or crimped, which helps hold the component to the PCB during soldering.

Ingress Protection rating type IP 54 (high level of protection against dust and also against water splashing), according to IEC 60529. Plastic materials (housing and rotor) are self-extinguishable according to UL 94 V-0 for ACP's cermet potentiometers.

Tapers can be linear, log and antilog; special tapers can also be studied.

Potentiometers can be manufactured in a wide range of possibilities regarding:

- Resistance value.
- Tolerance.
- Tapers / variation laws.
- Pitch.
- Positioning of the wiper (the standard is at 50%).
- Housing and rotor color.
- Mechanical life.
- Click effect (up to 20 detents available).

### Applications

9mm cermet potentiometers are used in applications where either the operating temperature is high or where the application requires product with excellent ohmic value stability:

- Electronic appliances: temperature controls.
- Automotive: climate controls, position sensors, seat heating controls.
- Industrial electronics: multimeters, oscilloscopes, time relays, measurement and test equipment.



# MCA9 MCE9 HOW TO ORDER

EXAMPLE: **MCA9DH5-10KA2020 SNP PI WT-9020-NE**

EXAMPLE: **MCE9DH5-10KA2020 SNP PI WT-9020-NE-V0**

Standard features								Extra features							Assembled accessory			
Series	Rotor	Model	Packg.	Ohm value	Taper	Tol.	Life	Track	Detents	Snap in	Housing	Rotor	Wiper	Lin.	Assembly	Ref #	Color	Flam.
1	2	3	4	5	6	7	8	9	10	11	12	13	14	15	16			
MCA9/MCE9	D	H5		- 10K	A	2020				SNP			PI		WT	-9020	-NE	-V0

Standard configuration:	MCA9 Through-hole	MCE9 Through-hole
Dimensions:	9mm	
Protection:	IP 54 (dust-proof) On request: Self-extinguishable, to meet UL 94 V-0	
Substrate:	Carbon technology	Cermet
Color:	Blue housing + white rotor	Brown housing + white rotor
Packaging:	Bulk	
Wiper position:	at 50% ±15°	
Terminals:	Straight, without crimping.	
Marking:	Resistive value marked on housing. Others on request.	

**Customized products:** A drawing is requested when ordering a customized product. Series, rotor, model and total resistive value are indicated before the code that includes all special specifications. Example: MCA9DH2,5-10K CODE C00111.

## 1 - Series

■ MCA9 ■ MCE9

## 2 - Rotors

D

## 3 - Model and pitch

H2,5 H3,8 H5 V7,5 V10 VK10 VR10

## 4 - Packaging

### Trough-hole

Bulk (blank)

## 5 - Resistance value

100Ω 200Ω 220Ω 250Ω 470Ω 500Ω 1KΩ 2KΩ ... 500KΩ 1MΩ 2MΩ 2M2 4M7Ω 5MΩ  
100 200 220 250 470 500 1K 2K 500K 1M 2M 2M2 4M7 5M

## 6 - Resistance law / taper

Lin - Linear A  
Log - Logarithmic B  
Antilog - Antilogarithmic C  
- Special tapers have codes assigned: CODE YXXXXX

## 7 - Tolerance

±20% ±30% +50%,-30% ±10% ±5%  
2020 3030 5030 1010 0505

## 8 - Operating Life (Cycles)

Standard (1.000 cycles) (leave blank)  
Long life: LV + the number of cycles. ex: LV45 for 45.000 cycles. (others on request) LVXX: ex: LV45

## 9 - Cut Track – Open circuit.

Open circuit at beginning of track, fully CCW PCI  
Open circuit at end of track, fully CW PCF

## 10 - Detents (DT)

One detent at the beginning DTI  
One detent at the end DTF  
X number of detents, evenly distributed. XDT: 10DT

Special detents are available on request: If you also need to assign a voltage value to each detent, please inquire.

## 11 - Terminals

SNAP IN P SNP  
SNAP IN J SNJ  
Shorter tip of terminal, TPXX, where XX is tip length (under request) TPXX, ex: TP25  
Steel Terminals SH

## 12 - Housing

**Color:** For colors other than standard: -See color chart below- CJ-color, ex., red: CJ-RO

## 13 - Rotor

**Color:** For colors other than standard: -See color chart below- RT-color; ex., blue: RT-AZ

**\* Self-extinguishable property, V0, for housing and rotor:** (blank)  
By default, carbon is non self-extinguishable, cermet is Self-extinguishable: V0  
For carbon: self-extinguishable property can be added. V0 means housing CJ-V0, RT-V0  
and rotor are V0. If only the housing needs to be V0, then CJ-V0.  
If only rotor: RT-V0

## 14 - Wiper

**Wiper position** (Standard: 50% ± 15°) (leave blank)  
Initial or CCW PI  
Final or CW PF  
Others: following clock positions; at 3 hours: P3H PXH, ex: P3H  
**Wiper torque** (Standard: <2.5Ncm, for detents: <3.5) (leave blank)  
Low torque, < 1.5Ncm PGB

## 15 - Linearity

Not controlled (leave blank)  
Independent linearity controlled & below x%, for example, 3%: LN3% LNx%; ex: LN3%  
Absolute linearity controlled & below x% LAX%

## 16 - Potentiometers with assembled accessories

Assembled from terminal side WT-  
Accessory Reference (9019 or 9020) -XXXXX, Example: 9019  
Color of shaft -YY Example, black: NE  
Non self-extinguishable. (leave blank)  
Self-extinguishable according to standard UL 94 -V0  
(-V0 in box 17 modifies only the accessory, please, note.)

## Color chart for rotor, housing and accessories

Black <sup>(1)</sup>	White	Neutral	Transp.	Red	Green	Yellow	Blue	Grey	Brown
NE	BA	IN	TA	RO	VE	AM	AZ	GS	MR

(1) black is not an option for housings.

## Models

All models shown here have shaft 9020, but other shafts can be chosen from the list below (Page 71). The D dimension indicated on the drawings refers to the possible length of the shaft, to be chosen at "shafts" section. Potentiometers are sold separately from the nuts and washers.

### H2,5

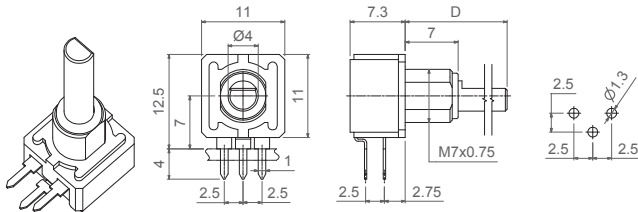

### H3,8

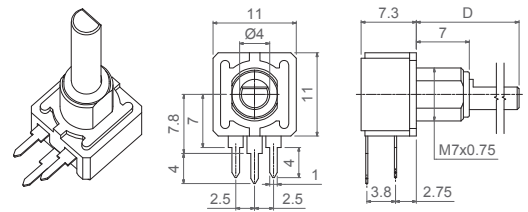

### H5

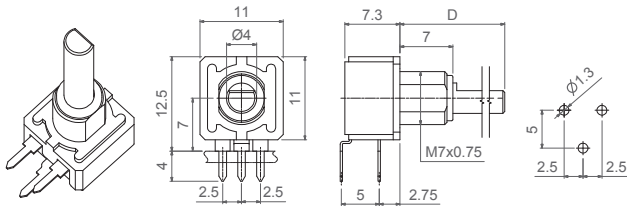

### V7,5

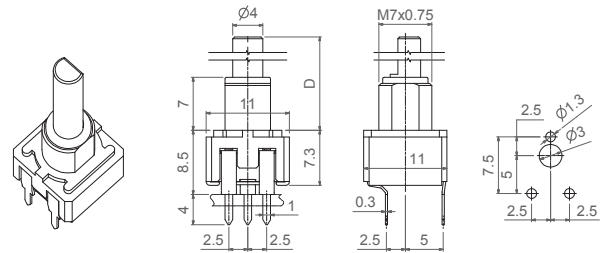

### V10

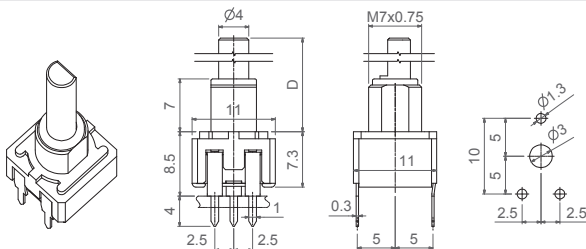

### VK10

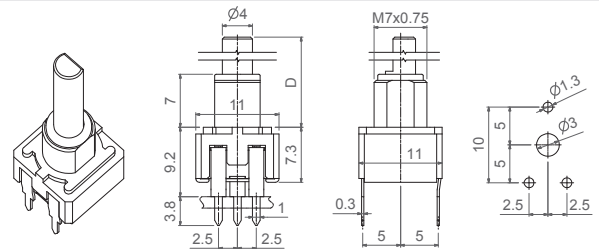

### VR10

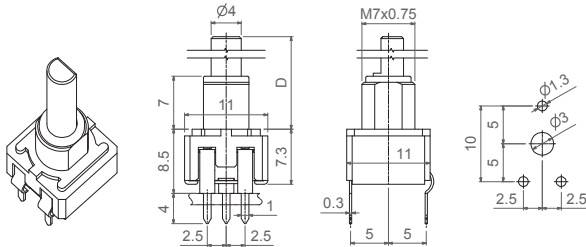

### Nut

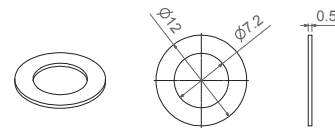

### Washer

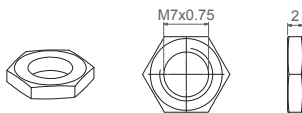

### Nut and washer assembly indication

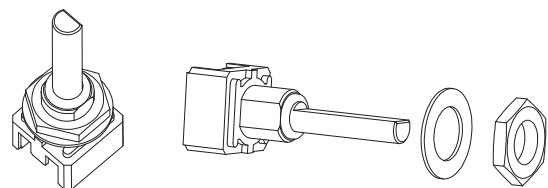

## Tapers

The standard taper is linear (A). Log (B) and Antilog (C) tapers are also available, as well as special tapers according to customer's specifications. For example, a special taper can be matched with a potentiometer with detents (click effect), to guarantee a value in a specific position – see "detents" section.-

### REGULAR TAPERS

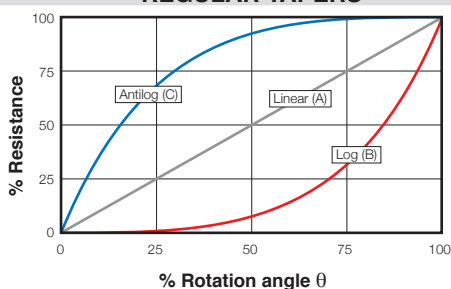

### SPECIAL TAPERS

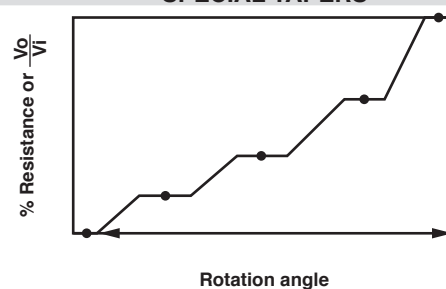

## Potentiometers with cut track

The cut track is an area with very high resistive value, resulting in an open circuit. It is widely used in lighting applications.

Mechanical life with cut track needs to be confirmed.

PCI = Cut at initial position, when the potentiometer is turned fully counter clockwise.

PCF = Cut at final position, when the potentiometer is turned fully clockwise.

Other positions are available on request.

### PCI

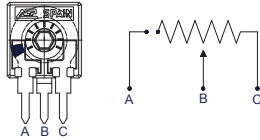

### PCF

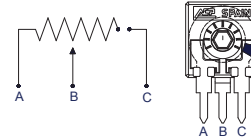

## Potentiometers with detents

ACP's patented detent (DT) feature is especially suitable for control applications where the end user will turn a knob inserted in the potentiometer. Detents can be used to add a click feeling to the turning of the potentiometer or to control the position in which the wiper is placed, assuring a particular output value with a narrow tolerance.

Detents can be light or strong, or even a combination of different feelings. They can be evenly distributed along the angle (standard) or tailored to match customers' request. They can also be combined with special tapers: constant value areas, open circuit zone, different slopes, etc. One common example is a potentiometer with detents and matching non-overlapping voltage values in specific angular positions, used to feed in a voltage value to a microprocessor:

### Example of 5DT with control of value in each DT.

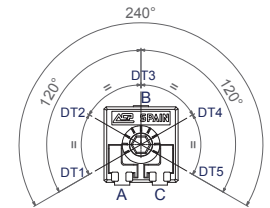
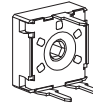
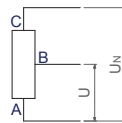
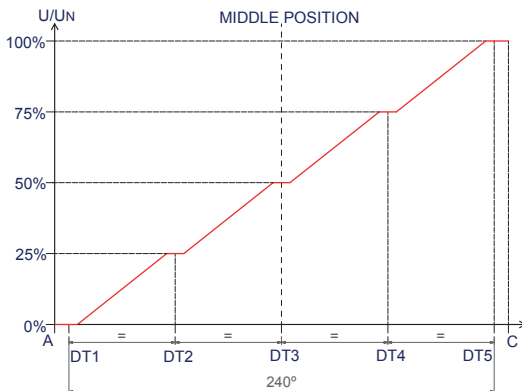

Other examples of potentiometers with detents:

### 10DT

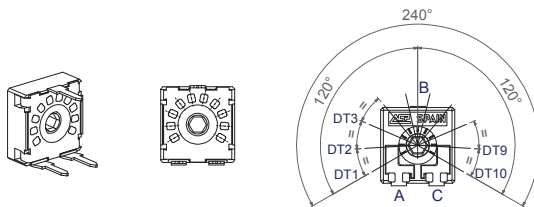

### 20DT

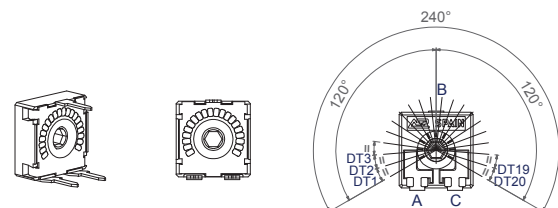

Number of standard detents (evenly distributed) already available.

1 (initial or final), 2 DT (initial and final), 3, 4, 5, 6, 7, 8, 10, 20.

Maximum number of detents for feeling only

20

Maximum number of detents when the voltage value in each detent is controlled and non-overlapping.

10

Our patented design with two wipers has improved the performance of these potentiometers, giving them more stable electrical parameters, improved reliability and Contact Resistance Variation (CRV) as well as narrower tolerances for detent positioning.

For potentiometers with detents, mechanical life is also 1.000 cycles, if no additional cycles are mentioned. Please, indicate the number of cycles needed with LV (number of cycles), for example: LV07, for 7.000 cycles.

When needing a special number of detents or matching taper, a drawing is kindly requested.

## Terminals

By default, terminals are always straight, as shown on the “models” section. ACP can provide crimped terminals (with snap in, “SNP” or “SNJ”), to better hold the component to the PCB during the soldering operation.

### SNP

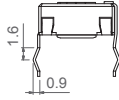

### SNJ

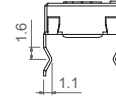

Also, there is an option of having shorter terminal tips:

### Standard Terminal

### Shorter terminal, for H5 TP25

### Shorter terminal, TPXX (under request)

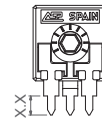
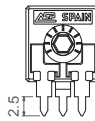
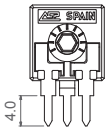

## Possibilities for insertion of accessories

Should the shaft need to be positioned differently than shown on the “models” section on this catalogue, a drawing with the exact position is kindly requested.

## Shafts

Shafts are available in different colors (color chart in “how to order” section) and with self-extinguishable property, according to UL 94 V-0, under request. ACP can study special shaft designs.

D dimension is the distance from the housing to the top of the shaft, as shown in the different models.

<b>Shaft</b>	9019	9020
<b>D Dimension</b>	17.5	23.5

### 9019

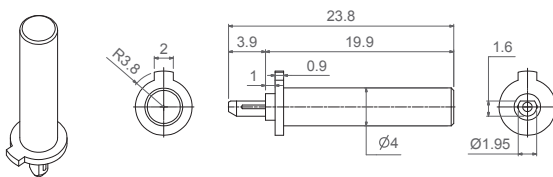

### 9020

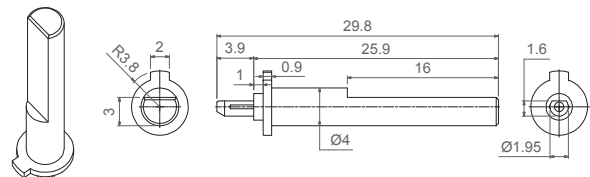

## Packaging

Potentiometer model	With shaft or thumbwheel inserted?	Pieces per bigger box (250 x 150 x 70, CG on description)
H2,5 - H3,8 - H5 V7,5 - V10 - VK10 - VR10	9019, 9020	500

## Electric Specifications

These are standard features; other specifications and out of range values can be studied on request.

	MCA9 Through-hole	MCE9 Through-hole
Range of resistance values* Lin (A) Log (B) Antilog (C)	$100\Omega \leq R_n \leq 5M\Omega$ $1 K\Omega \leq R_n \leq 2M2\Omega$	$100\Omega \leq R_n \leq 5M\Omega$ $1 K\Omega \leq R_n \leq 2M2\Omega$
Tolerance* Rn < 100Ω: 100Ω ≤ Rn ≤ 100KΩ: 100K < Rn ≤ 1MΩ: 1MΩ < Rn ≤ 5MΩ: Rn > 5MΩ:	+50%, -30% (out of range) ±20% ±20% ±30% +50%, -30% (out of range)	- ±20% ±20% ±30% -
Variation laws	Lin (A), Log (B), Antilog (C). Other tapers available on request	
Residual resistance	Lin (A), Log (B), Antilog (C) ≤ 5*10 <sup>-3</sup> *Rn. Minimum value 2Ω	≤2Ω
CRV - Contact Resistance Variation (dynamic)	Lin (A) Electrical Angle 220°±20° ≤ 3%Rn. Other tapers, please inquire	
CRV - Contact Resistance Variation (static)	Lin (A) Electrical Angle 220°±20° ≤ 5%Rn. Other tapers, please inquire	
Maximum power dissipation** Lin (A) Log (B), Antilog (C)	at 50°C 0.15W 0.10W	at 70° C. 0.5W 0.20W
Maximum voltage Lin (A) Log (B), Antilog (C)	150VDC 200VDC	200VDC
Operating temperature	-25°C ... +70°C (+85°C on request)	-40°C ... +90°C (+125°C on request)
Temperature coefficient 100Ω ≤ Rn ≤ 10KΩ 10KΩ < Rn ≤ 5MΩ	+200/ -300 ppm +200/ -500 ppm	±100 ppm ±100 ppm

\* Out of range ohm values and tolerances are available on request, please, inquire.

\*\* Dissipation of special tapers will vary, please, inquire.

## Mechanical Specifications

	MCA9 Through-hole	MCE9 Through-hole
Resistive element	Carbon technology	Cermet
Angle of rotation (mechanical)	240° ± 5°	
Angle of rotation (electrical)	220° ± 20°	
Wiper standard delivery position	50% ± 15°	
Max. stop torque	5 Ncm	
Max. push/pull on rotor	40 N	
Wiper torque*	<2 Ncm Potentiometers with detents: <2.5 Ncm	
Mechanical life	1.000 cycles (many more available on request, please, inquire)	

\* Stronger or softer torque feeling is available on request.

## Test results

The following typical test results are given at 23°C ±2°C and 50% ±25% RH.

	MCA9 Through-hole		MCE9 Through-hole	
	Test conditions	Typical variation of nominal resistance	Test conditions	Typical variation of nominal resistance
Damp heat	500 h. at 40°C and 95% RH	+5%, -2%	500 h. at 40°C and 95% RH	±2%
Thermal cycles	16 h at 85°C, plus 2 h at -25°C	±2.5%	16 h at 90°C, plus 2 h at -40°C	±2%
Load life	1.000 h. at 50°C	+0%; -6%	1.000 h. at 70°C	±2%
Mechanical life	1.000 cycles at 10 c.p.m. and at 23°C ± 2°C	±3%	1.000 cycles at 10 c.p.m. and at 23°C ± 2°C	±3%
Storage (3 years)	3 years at 23°C ± 2°C	±3%	3 years at 23°C ± 2°C	±1%

MCA9 Through-hole

MCE9 Through-hole

Power derating curve:

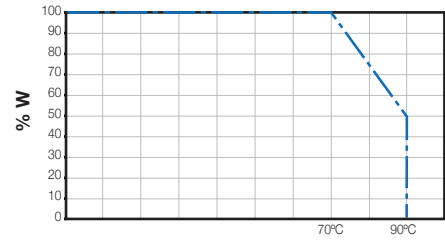
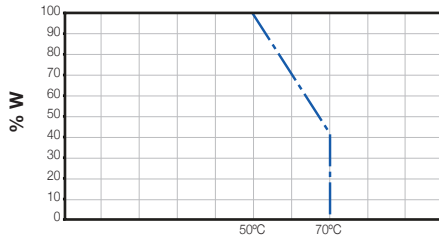

**For temperatures out of range**

The normal operation temperature for a carbon ACP potentiometer is -25°C to +70°C. When the temperature goes up to 85°C, the following variations should be observed:

Load life	1.000 h. at 50°C	+0%; -6%	1.000 h. at 85°C	+0%; -15%
-----------	------------------	----------	------------------	-----------

The power derating curve to consider is:

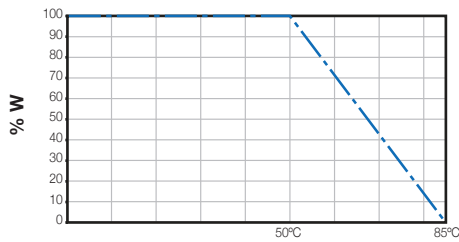

Representation of the typical variation of nominal resistance (with 95% confidence) throughout the ohm value range:

MCA9 Through-hole

MCE9 Through-hole

Damp heat

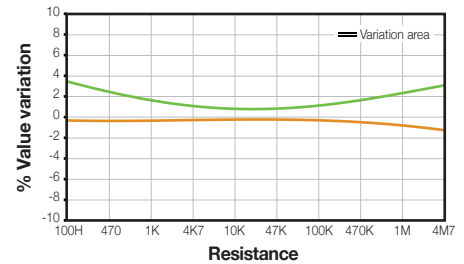
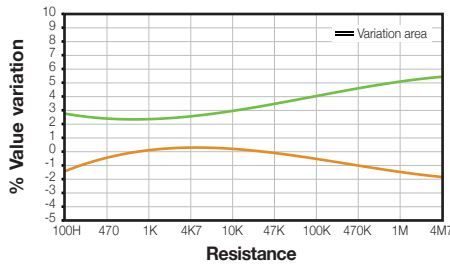

Temperature Coefficient

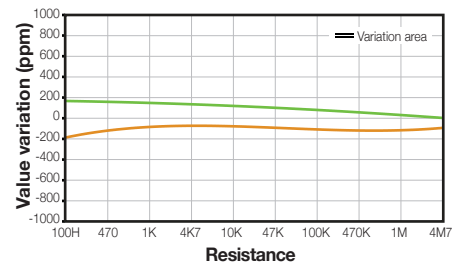
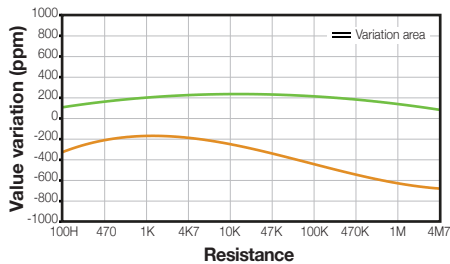

Load life

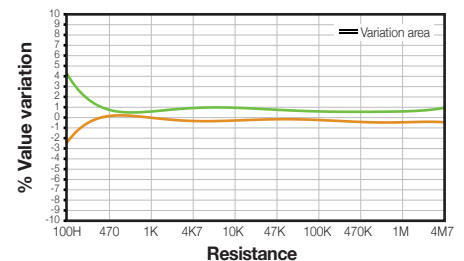
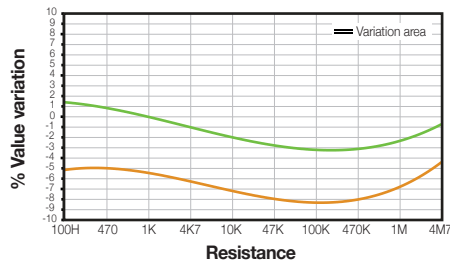

Mechanical life

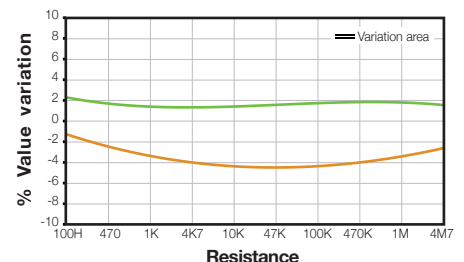
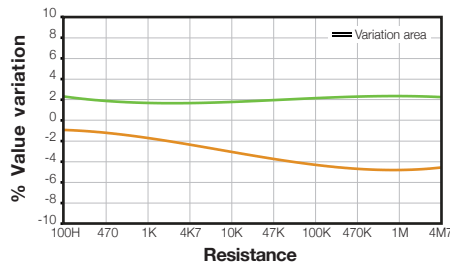

# MCA14

Control Carbon  
Potentiometers MCA

# MCE14

Control Cermet  
Potentiometers MCE

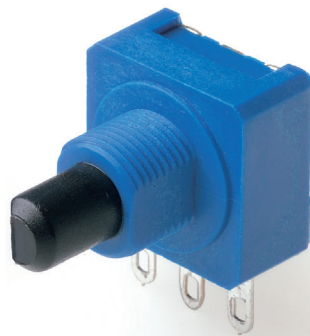
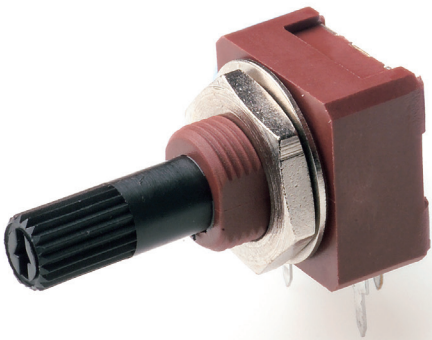

## CARBON – MCA14

14mm carbon potentiometers with plastic enclosure and shaft.

Through-hole and SMD configurations are available. Terminals and collector are normally manufactured in tinned brass, although versions with steel terminals are also available under request. Terminals for through-hole models can be provided straight or crimped, which helps hold the component to the PCB during soldering.

Ingress Protection rating type IP 54 (high level of protection against dust and also against water splashing), according to IEC 60529. Plastic materials can be self-extinguishable according to UL 94 V-0 under request.

Tapers can be linear, log and antilog; special tapers can also be studied.

Potentiometers can be manufactured in a wide range of possibilities regarding:

- Resistance value.
- Tolerance.
- Tapers / variation laws.
- Pitch.
- Positioning of the wiper (standard is at 50% rotation).
- Housing and rotor color.
- Mechanical life.
- Click effect (up to 38 detents available).
- Self-extinguishable plastic parts according to UL 94 V-0.

### Applications

14mm potentiometers are mainly used in control applications, in different markets:

- Electronic household appliances, heating, ventilation and air conditioning (HVAC) equipment, thermostats.

## CERMET – MCE14

14mm cermet potentiometers with plastic enclosure and shaft. Cermet potentiometers have better thermal stability, allow for higher thermal dissipation and withstand higher temperatures than carbon potentiometers.

Through-hole and SMD configurations are available. Terminals and collector are manufactured in tinned brass, although versions with steel terminals are also available under request. Terminals for through-hole models can be provided straight or crimped, which helps hold the component to the PCB during soldering.

Ingress Protection rating type IP 54 (high level of protection against dust and also against water splashing), according to IEC 60529. Plastic materials (housing and rotor) are self-extinguishable according to UL 94 V-0 for ACP's cermet potentiometers.

Tapers can be linear, log and antilog; special tapers can also be studied.

Potentiometers can be manufactured in a wide range of possibilities regarding:

- Resistance value.
- Tolerance.
- Tapers / variation laws.
- Pitch.
- Positioning of the wiper (the standard is at 50%).
- Housing and rotor color.
- Mechanical life.
- Click effect (up to 38 detents available).

### Applications

14mm cermet potentiometers are used in applications where either the operating temperature is high, or where the applications requires product with excellent ohmic value stability:

- Electronic appliances: boilers, water heaters.
- Industrial electronics: multimeters, oscilloscopes, time relays, measurement and test equipment.



# MCA14 MCE14 HOW TO ORDER

EXAMPLE: **MCA14NH2,5-10KA2020 SNP PI WT-14187-BA**

EXAMPLE: **MCE14NH2,5-10KA2020 SNP PI WT-14187-BA-V0**

Standard features								Extra features							Assembled accessory			
Series	Rotor	Model	Packg.	Ohm value	Taper	Tol.	Life	Track	Detents	Snap in	Housing	Rotor	Wiper	Lin.	Assembly	Ref #	Color	Flam.
1	2	3	4	5	6	7	8	9	10	11	12	13	14	15	16			
MCA14 MCE14	N	H2,5		- 10K	A	2020		SNP				PI			WT	-14187	-BA	

Standard configuration:	MCA14 Through-hole	MCE14 Through-hole
Dimensions:	14mm	
Protection:	IP 54 (dust-proof) On request: Self-extinguishable, to meet UL 94 V-0	
Substrate:	Carbon technology	Cermet
Color:	Blue housing + white rotor	Brown housing + white rotor
Packaging:	Bulk	
Wiper position:	at 50% ±15°	
Terminals:	Straight, without crimping.	
Marking:	Resistive value marked on housing. Others on request.	

**Customized products:** A drawing is requested when ordering a customized product. Series, rotor, model and total resistive value are indicated before the code that includes all special specifications. Example: MCA14PH2,5-10K CODE C00111. Other features could be available on request, please, ask.

## 1 - Series

■ MCA14 ■ MCE14

## 2 - Rotors

N Z

## 3 - Model and pitch

H0	HC0	H2,5	H4	H5	HA5	HL5	V12,5
VA12,5	VL12,5	VR12,5	V15	VJ15	V17,5	VD7,5	VD11

## 4 - Packaging

### Trough-hole

Bulk (blank)...<sup>(1)</sup>

## 5 - Resistance value

100Ω	200Ω	220Ω	250Ω	470Ω	500Ω	1KΩ	2KΩ	...	500KΩ	1MΩ	2MΩ	2M2Ω	4M7Ω	5MΩ
100	200	220	250	470	500	1K	2K		500K	1M	2M	2M2	4M7	5M

## 6 - Resistance law / taper

Lin - Linear	A
Log - Logarithmic	B
Antilog - Antilogarithmic	C
- Special tapers have codes assigned:	CODE YXXXXX

## 7 - Tolerance

±20%	±30%	+50%,-30%	±10%	±5%
2020	3030	5030	1010	0505

## 8 - Operating Life (Cycles)

Standard (1.000 cycles)	(leave blank)
Long life: LV + the number of cycles. ex: LV45 for 45.000 cycles. (others on request)	LVXX: ex: LV45

## 9 - Cut Track - Open circuit.

Open circuit at beginning of track, fully CCW	PCI
Open circuit at end of track, fully CW	PCF

## 10 - Detents (DT)

One detent at the beginning	DTI
One detent at the end	DTF
X number of detents	XDT: 10DT

Special detents are available on request: If you also need to assign a voltage value to each detent, please inquire.

## 11 - Terminals

SNAP IN P	SNP
SNAP IN J	SNJ
Shorter tip of terminal, TPXX, where XX is tip length (under request)	TPXX, ex: TP25
Steel Terminals	SH

## 12 - Housing

**Color:** For colors other than standard: -See color chart below- CJ-color, ex., red: CJ-RO

## 13 - Rotor

**Color:** For colors other than standard: -See color chart below- RT-color; ex., blue: RT-AZ

### \* Self-extinguishable property, V0, for housing and rotor:

By default, carbon is non self-extinguishable, cermet is Self-extinguishable: (blank)  
For carbon: self-extinguishable property can be added. V0 means housing and rotor are V0. If only the housing needs to be V0, then CJ-V0. CJ-V0, RT-V0  
If only rotor: RT-V0

## 14 - Wiper

<b>Wiper position</b> (Standard: 50% ± 15°)	(leave blank)
Initial or CCW	PI
Final or CW	PF
Others: following clock positions; at 3 hours: P3H	PXH, ex: P3H
<b>Wiper torque</b> (Standard: <2.5Ncm, for detents: <3.5)	(leave blank)
Low torque, < 1.5Ncm	PGB

## 15 - Linearity

Not controlled	(leave blank)
Independent linearity controlled & below x%, for example, 3%: LN3%	LNx%; ex: LN3%
Absolute linearity controlled & below x%	LAX%

## 16 - Potentiometers with assembled accessories

Assembled from terminal side	WT
Accessory Reference	-XXXXX
See list of shafts and thumbwheels available	Example: 14187
Color of shaft or thumbwheel	-YY Example, white: BA
Non self-extinguishable. Self-extinguishable according to standard UL 94 (-V0 in box 17 modifies only the accessory, please, note.)	(leave blank) -V0

## Color chart for rotor, housing and accessories

Black <sup>(1)</sup>	White	Neutral	Transp.	Red	Green	Yellow	Blue	Grey	Brown
NE	BA	IN	TA	RO	VE	AM	AZ	GS	MR

(1) black is not an option for housings.

All models shown here have shaft 14187, but other shafts can be chosen from the list below. The D dimension indicated on the drawings refers to the possible length of the shaft, to be chosen at "shafts" section. Potentiometers are sold separately from the nuts and washers.

**H0**

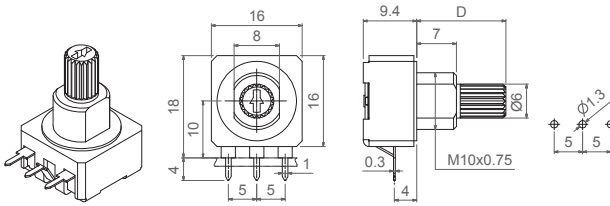

**HC0**

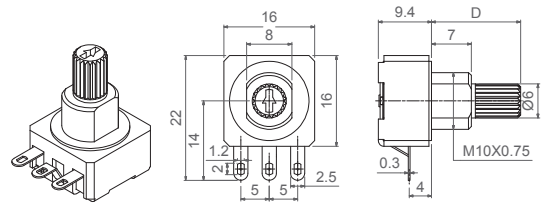

**H2,5**

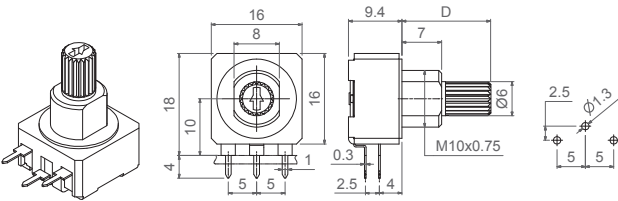

**H4**

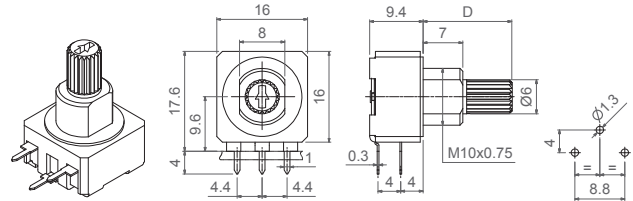

**H5**

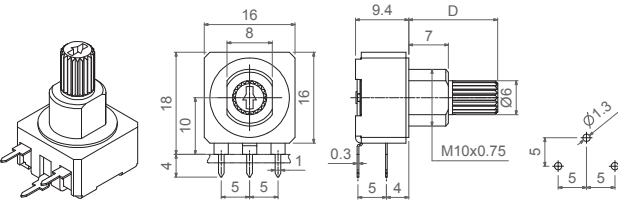

**HA5**

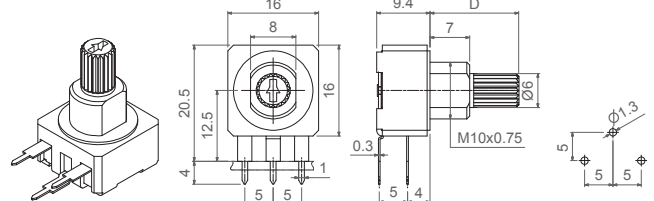

**HL5**

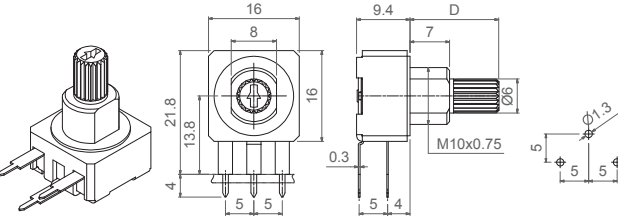

**V12,5**

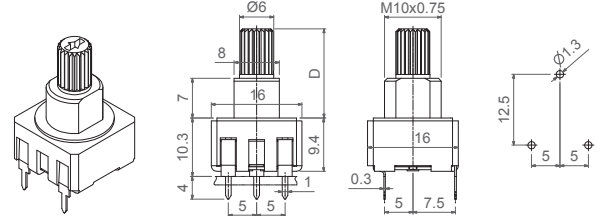

**VA12,5**

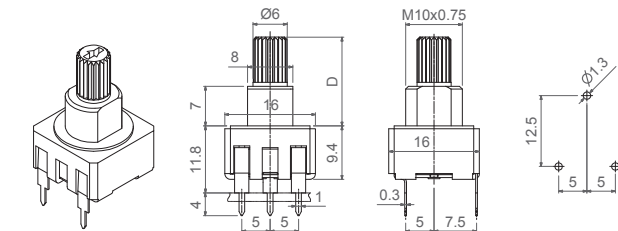

**VL12,5**

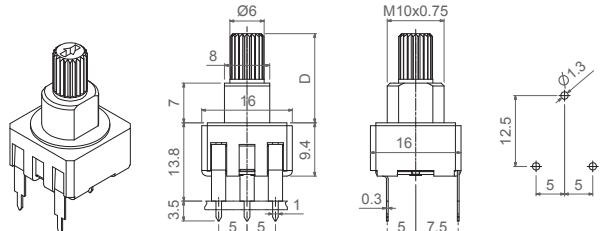

**VR12,5**

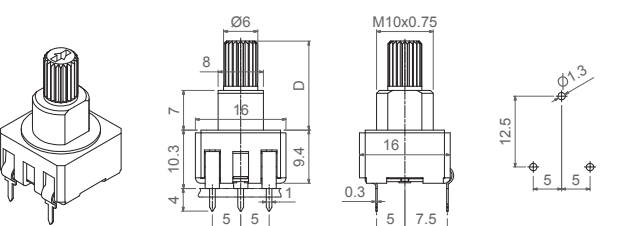

**V15**

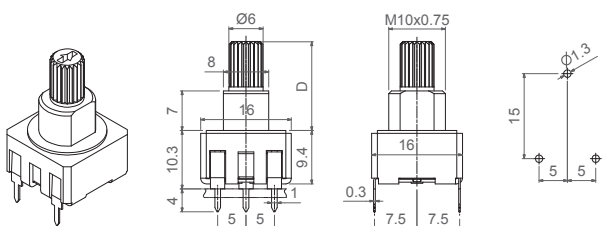

VJ15

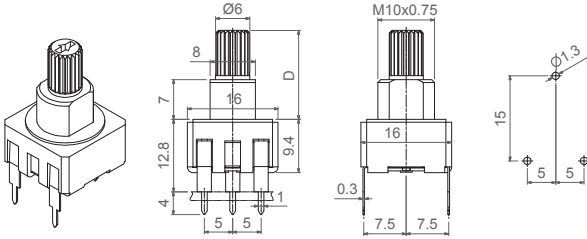

V17,5

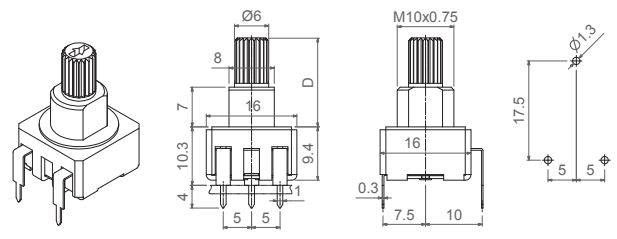

VD7,5

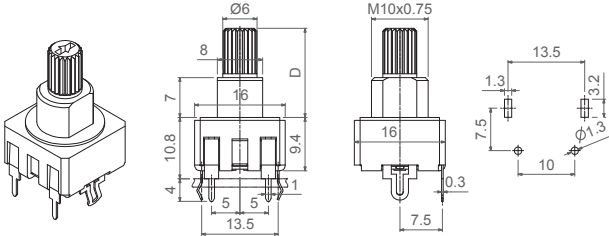

VD11

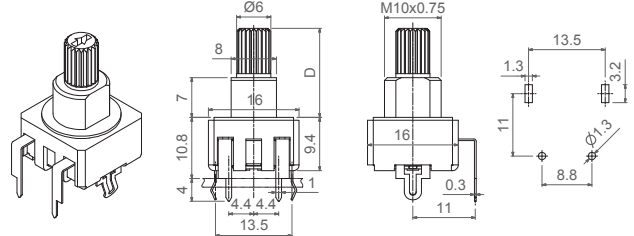

Nut

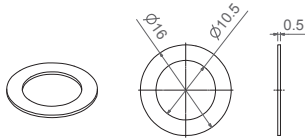

Washer

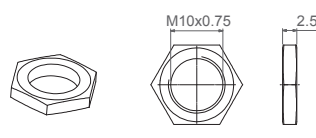

Nut and washer assembly indication

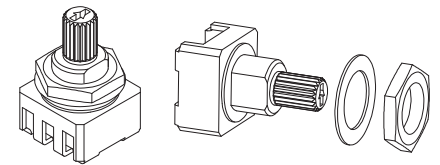

Tapers

The standard taper is linear (A). Log (B) and Antilog (C) tapers are also available, as well as special tapers according to customer's specifications. For example, a special taper can be matched with a potentiometer with detents (click effect), to guarantee a value in a specific position – see "detents" section. -

REGULAR TAPERS

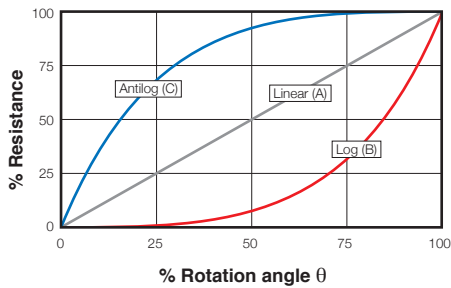

SPECIAL TAPERS

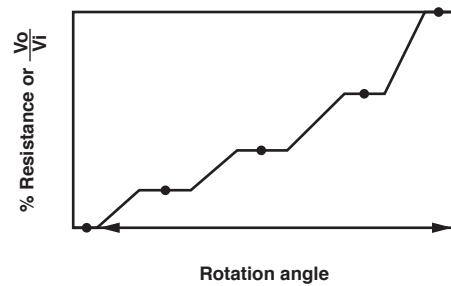

Potentiometers with cut track

The cut track is an area with very high resistive value, resulting in an open circuit. It is widely used in lighting applications.

Mechanical life with cut track needs to be confirmed.

PCI = Cut at initial position, when the potentiometer is turned fully counter clockwise.

PCF = Cut at final position, when the potentiometer is turned fully clockwise.

Other positions are available on request.

PCI

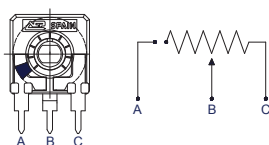

PCF

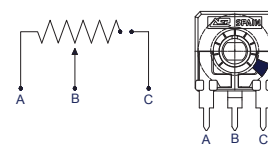

## Potentiometers with detents

ACP's patented detent (DT) feature is especially suitable for control applications where the end user will turn a knob inserted in the potentiometer. Detents can be used to add a click feeling to the turning of the potentiometer or to control the position in which the wiper is placed, assuring a particular output value with a narrow tolerance.

Detents can be light or strong, or even a combination of different feelings. They can be evenly distributed along the angle (standard) or tailored to match customers' request. They can also be combined with special tapers: constant value areas, open circuit zone, different slopes, etc. One common example is a potentiometer with detents and matching non-overlapping voltage values in specific angular positions, used to feed in a voltage value to a microprocessor:

### Example of 5DT with control of value in each DT.

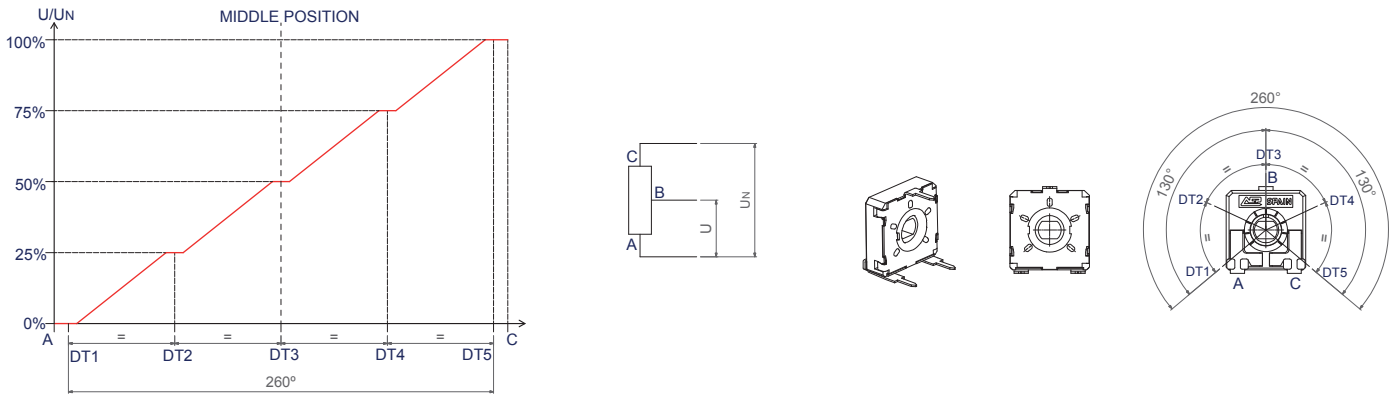

Examples of some potentiometers with detents:

### 14DT

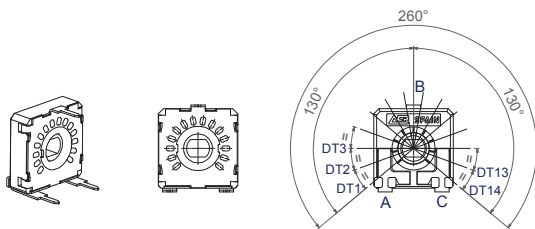

### 38DT

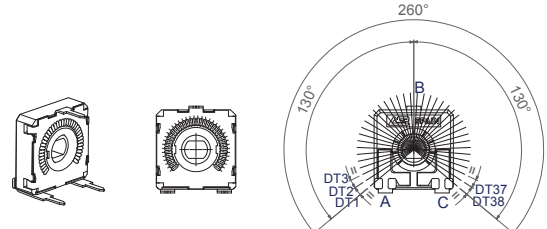

<b>Number of standard detents (evenly distributed) already available.</b>	1 (Initial, final or central), 3, 4, 5, 6, 7, 8, 9, 10, 13, 14, 17, 22, 27, 38.
<b>Maximum number of detents for feeling only</b>	38
<b>Maximum number of detents when the voltage value in each detent is controlled and non-overlapping.</b>	14

Our patented design with two wipers has improved the performance of these potentiometers, giving them more stable electrical parameters, improved reliability and Contact Resistance Variation (CRV) and narrower tolerances for detent positioning.

For potentiometers with detents, mechanical life is also 1.000 cycles if no additional cycles are mentioned. Up to 10.000 cycles are available. Please, indicate the number of cycles needed with LV (number of cycles), for example: LV10, for 10.000 cycles.

When needing a special number of detents or matching taper, a drawing is kindly requested.

## Terminals

By default, terminals are always straight, as shown on the “models” section. ACP can provide crimped terminals (with snap in, “SNP” or “SNR”), to better hold the component to the PCB during the soldering operation.

### SNP

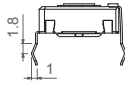

### SNR

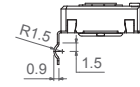

Also, there is an option of having shorter terminal tips:

### Standard Terminal

### Shorter terminal, for V12,5 TP30

### Shorter terminal, TPXX (under request)

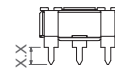
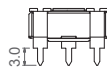
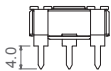

## Adjustment and orientation

Should the shaft need to be positioned differently than shown on the “models” section on this catalogue, a drawing with the exact position is kindly requested.

## Shafts

Shafts are available in different colors (color chart in “how to order” section) and with self-extinguishable property, according to UL 94 V-0, under request. ACP can study special shaft designs.

D dimension is the distance from the housing to the top of the shaft, as shown in the different models.

Shaft	14081	14187	14067	14008	14015	14066	14084	14250	14072	14073
D Dimension	15.2	15.7	24.7	20.2	20.2	20.45	20.45	21.95	28.7	35.45

### 14008

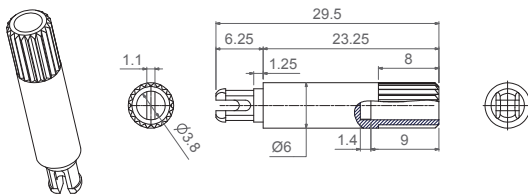

### 14015

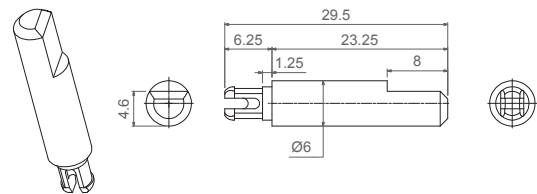

### 14066

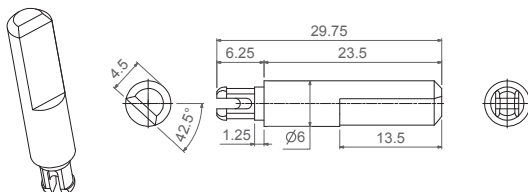

### 14067

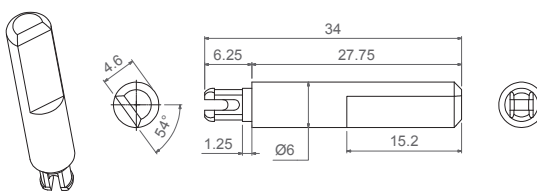

## Shafts

14072

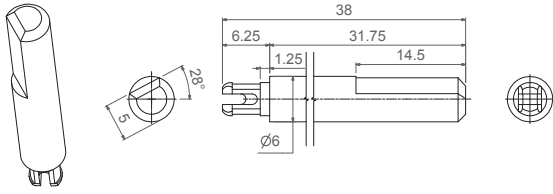

14073

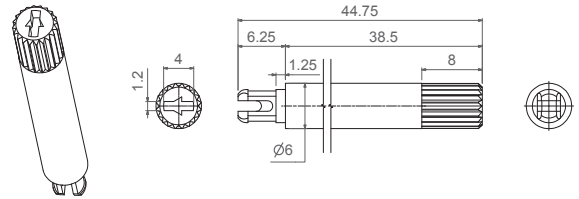

14081

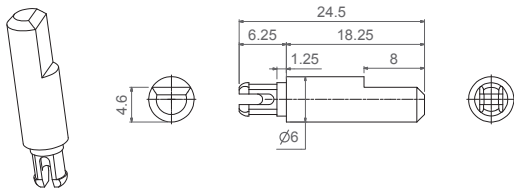

14084

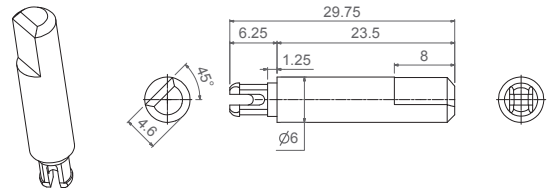

14187

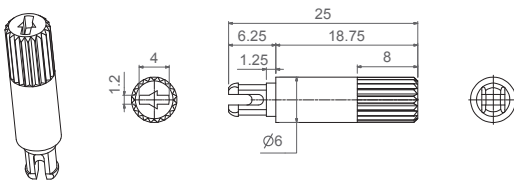

14250

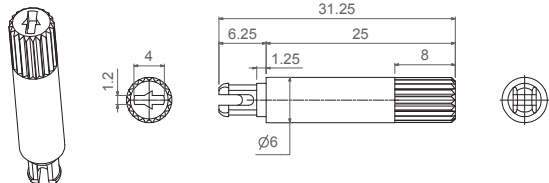

## Packaging

Potentiometer model	With shaft or thumbwheel inserted?	Pieces per bigger box (250 x 150 x 70, CG on description)
H0 - HC0 - H2,5 - H4 - H5 - HA5 - HL5 V12,5 - V15 - VA12,5 - VL12,5 - VR12,5 VJ15 - V17,5 - VD11 - VD7,5	With any shaft.	150

## Electric Specifications

These are standard features; other specifications and out of range values can be studied on request.

	MCA14 Through-hole	MCE14 Through-hole
Range of resistance values* Lin (A) Log (B) Antilog (C)	$100\Omega \leq R_n \leq 5M\Omega$ $1 K\Omega \leq R_n \leq 2M2\Omega$	$100\Omega \leq R_n \leq 5M\Omega$ $1 K\Omega \leq R_n \leq 2M2\Omega$
Tolerance* Rn < 100Ω: 100Ω ≤ Rn ≤ 100KΩ 100K < Rn ≤ 1MΩ: 1MΩ < Rn ≤ 5MΩ: Rn > 5MΩ:	+50%, -30% (out of range) ±20% ±20% ±30% +50%, -30% (out of range)	- ±20% ±20% ±30% -
Variation laws	Lin (A), Log (B), Antilog (C). Other tapers available on request	
Residual resistance	Lin (A), Log (B), Antilog (C) ≤ 5*10 <sup>-3</sup> *Rn. Minimum value 2Ω	≤2Ω
CRV - Contact Resistance Variation (dynamic)	Lin (A) Electrical Angle 245°±20° ≤ 3%Rn. Other tapers, please inquire	
CRV - Contact Resistance Variation (static)	Lin (A) Electrical Angle 245°±20° ≤ 5%Rn. Other tapers, please inquire	
Maximum power dissipation** Lin (A) Log (B), Antilog (C)	at 50°C 0.25W 0.13W	at 70°C. 0.7W 0.30W
Maximum voltage Lin (A) Log (B), Antilog (C)	250VDC 200VDC	
Operating temperature	-25°C ... +70°C (+85°C on request)	-40°C ... +90°C (+125°C on request)
Temperature coefficient 100Ω ≤ Rn ≤ 10KΩ 10KΩ < Rn ≤ 5MΩ	+200/ -300 ppm +200/ -500 ppm	±100 ppm ±100 ppm

\* Out of range ohm values and tolerances are available on request, please, inquire.

\*\* Dissipation of special tapers will vary, please, inquire.

## Mechanical Specifications

	MCA14 Through-hole	MCE14 Through-hole
Resistive element	Carbon technology	Cermet
Angle of rotation (mechanical)	265° ± 5°	
Angle of rotation (electrical)	245° ± 20°	
Wiper standard delivery position	50% ± 15°	
Max. stop torque	10 Ncm	
Max. push/pull on rotor	50 N	
Wiper torque*	<2.5 Ncm Potentiometers with detents: <3.5 Ncm	
Mechanical life	1.000 cycles (many more available on request, please, inquire)	

\* Stronger or softer torque feeling is available on request.

## Test results

The following typical test results (with 95% confidence) are given at 23°C ±2°C and 50% ±25% RH.

	MCA14 Through-hole		MCE14 Through-hole	
	Test conditions	Typical variation of Rn	Test conditions	Typical variation of Rn
Damp heat	500 h. at 40°C and 95% RH	+5%, -2%	500 h. at 40°C and 95% RH	±2%
Thermal cycles	16 h at 85°C, plus 2 h at -25°C	±2.5%	16 h at 90°C, plus 2 h at -40°C	±2%
Load life	1.000 h. at 50°C	+0%; -5%	1.000 h. at 70°C	±2%
Mechanical life	1.000 cycles at 10 c.p.m. and at 23°C ± 2°C	±3%	1.000 cycles at 10 c.p.m. and at 23°C ± 2°C	±2%
Storage (3 years)	3 years at 23°C ± 2°C	±3%	3 years at 23°C ± 2°C	±1%

MCA14 Through-hole

MCE14 Through-hole

Power derating curve:

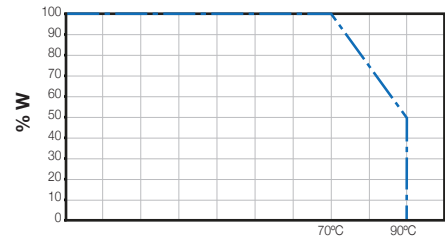
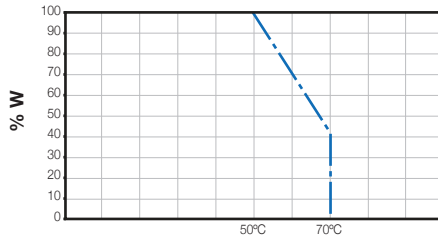

**For temperatures out of range**

The normal operation temperature for a carbon ACP potentiometer is -25°C to +70°C. When the temperature goes up to 85°C, the following variations should be observed:

Load life	1.000 h. at 50°C	+0%; -6%	1.000 h. at 85°C	+0%; -15%
-----------	------------------	----------	------------------	-----------

The power derating curve to consider is:

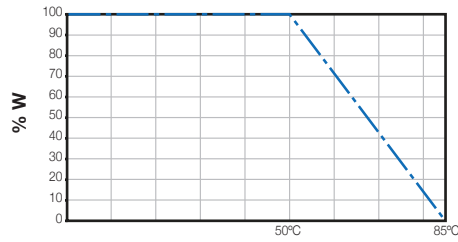

Representation of the typical variation of nominal resistance (with 95% confidence) throughout the ohm value range:

MCA14 Through-hole

MCE14 Through-hole

Damp heat

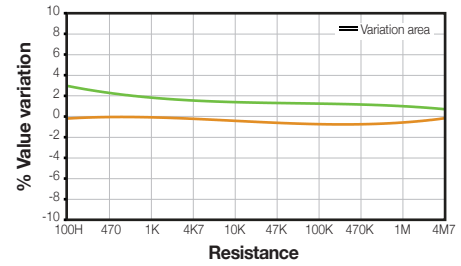
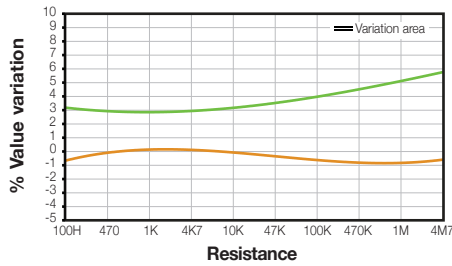

Temperature Coefficient

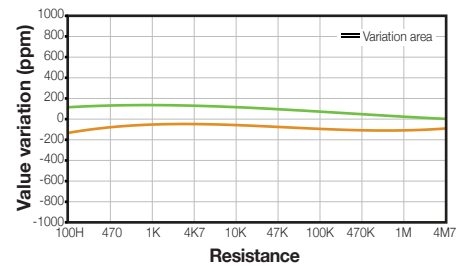
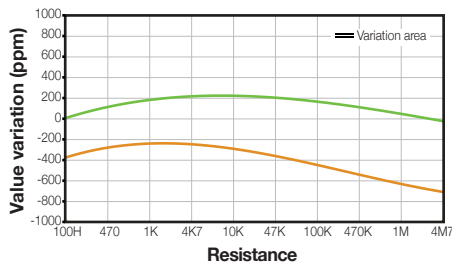

Load life

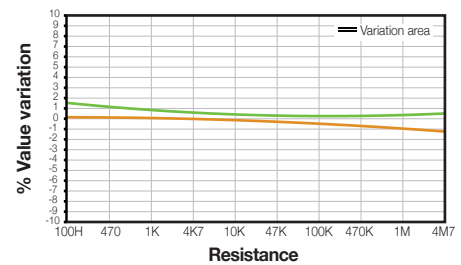
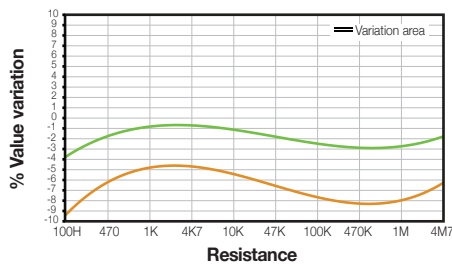

Mechanical life

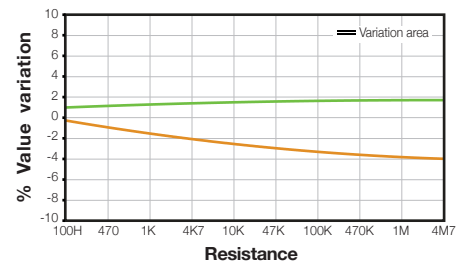
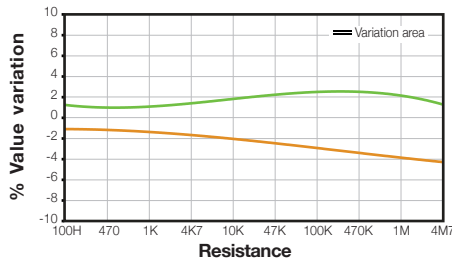





## **3 Rotary switches**

# COM

Rotary Switches

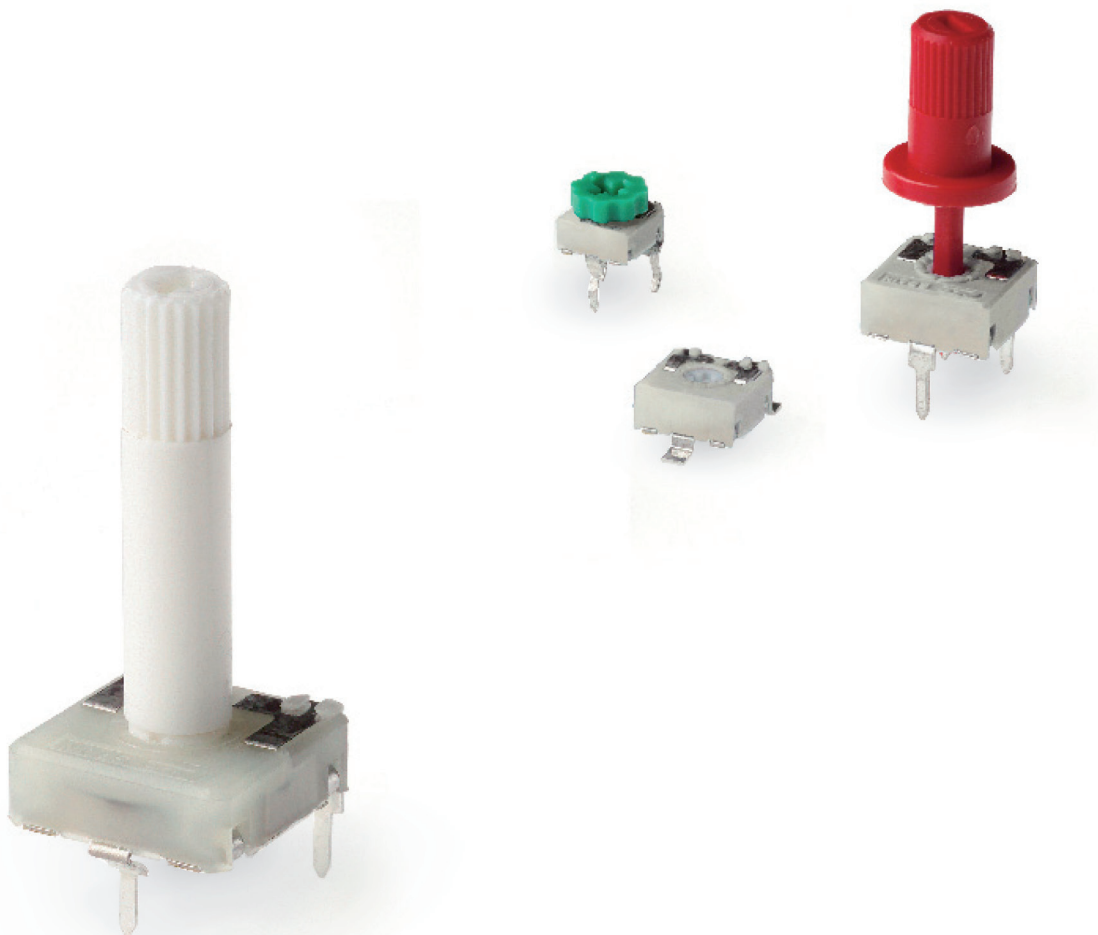

## ROTARY SWITCH – COM

Rotary switches are available in all different models already existing for the potentiometers: 6, 9 and 14mm in carbon and cermet technology. Please, refer to those sections to choose the external configuration of your switch.

ACP's Rotary switches are based on the design of the potentiometers: they have one input and two possible outputs. The commuting angle between outputs can be customized.

Through-hole and SMD configurations are available. Terminals and collector are normally manufactured in tinned brass, although versions with steel terminals are also available under request. Terminals for through-hole models can be provided straight or crimped, which helps hold the component to the PCB during soldering. The switch has Ingress Protection rating type IP 54 (high level of protection against dust and also against water splashing), according to IEC 60529. Plastic materials can be self-extinguishable according to UL 94 V-0 under request.

Thumbwheels and shafts can be provided either separately or already inserted in the switch.

Our switches can be manufactured in a wide range of possibilities regarding:

- Switching angle.
- Positioning of the wiper (the standard is at 50%).
- Housing and rotor color.
- Mechanical life.
- Pause effect (recommended for each possible circuit position).
- Self-extinguishable plastic parts, according to UL 94 V-0.

### Applications

- Dimmers.
- Telecommunications (antenna control).

# COM HOW TO ORDER

ACP's switches (COM) follow the same configuration as the potentiometers, as shown in previous sections of this catalogue. The word COM needs to be added to the description. The cells 5, 6 and 7 (value, taper and tol) are left blank. If the switching angle is different from our standard, then it should be indicated.

## Examples:

**From CA9: COMCA9MH2,5 2DT SNP PI WT-9005-BA** (switch in configuration CA9MH2,5 with 2 detents, terminals with snap in, wiper at CCW position, and white shaft reference 9005 already inserted).

Standard features								Extra features							Assembled accessory			
Series	Rotor	Model	Packg.	Ohm value	Taper	Tol.	Life	Track	Collector	Terminals	Housing	Rotor	Wiper position	Lin	Assembly	Ref #	Color	Flam.
1	2	3	4	5	6	7	8	9	10	11	12	13	14	15	16			17
COM CA9	M	H2,5		-	-	-			2DT	SNP			PI		WT	-9005	-BA	

**From CA14: COMCA14PV15 AC45°±15°** (switch in configuration CA14V15, switching angle at 45°).

Standard features								Extra features							Assembled accessory			
Series	Rotor	Model	Packg.	Ohm value	Taper	Tol.	Life	Track	Collector	Terminals	Housing	Rotor	Wiper position	Lin	Assembly	Ref #	Color	Flam.
1	2	3	4	5	6	7	8	9	10	11	12	13	14	15	16			17
COM CA14	P	V15		-	-	-		AC45°±15°										

## Electric Function

The three terminals of the potentiometer are equivalent to one input (B) and two outputs (A and C), as shown in the figure. The middle terminal (B) corresponds to the internal wiper, which switches between positions. The switching angle can be customized. Unless otherwise requested, the housing will be neutral color, with the marking in black.

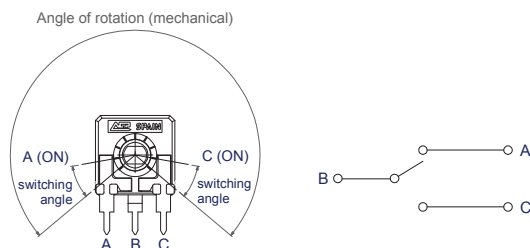

## Electric Specifications

	COM CA6	COM CA9 / MCA9 COM CA14 / MCA14	COM CE9 / MCE9 COM CE14 / MCE14
Resistive element	Carbon	Carbon	Cermet
Power ratio	15V / 12mA	24V / 12mA	24V / 12mA
Resistance at ON position	$\leq 5\Omega$	$\leq 5\Omega$	$\leq 5\Omega$
Dielectric Strength	600V	1500V	1500V
Insulation resistance	100M $\Omega$	100G $\Omega$	100G $\Omega$
Switching angle at ON position	$20^\circ \pm 15^\circ$	$30^\circ \pm 15^\circ$	$30^\circ \pm 15^\circ$
Operating temperature	-25°C... +70°C (+85°C)		-40°C... +90°C (+125°C)

Please, note that these are standard features; other specifications are available on request.

## Mechanical Specifications

	6mm	9mm	14mm
Angle of rotation	$235^\circ \pm 10^\circ$	$240^\circ \pm 5^\circ$	$265^\circ \pm 5^\circ$
Mechanical life	1.000	1.000	1.000
Wiper torque	< 2 Ncm	< 2 Ncm	< 2.5 Ncm
Max. stop torque	4 Ncm	5 Ncm (CA9, CE9) 25 Ncm (MCA9, MCE9)	10 Ncm (CA14, CE14) 15 Ncm (MCA14, MCE14)
Max. push/pull on rotor	9.8 N	40 N / 50 N	40 N / 50 N



## 4 Thick Film solutions



# THICK FILM

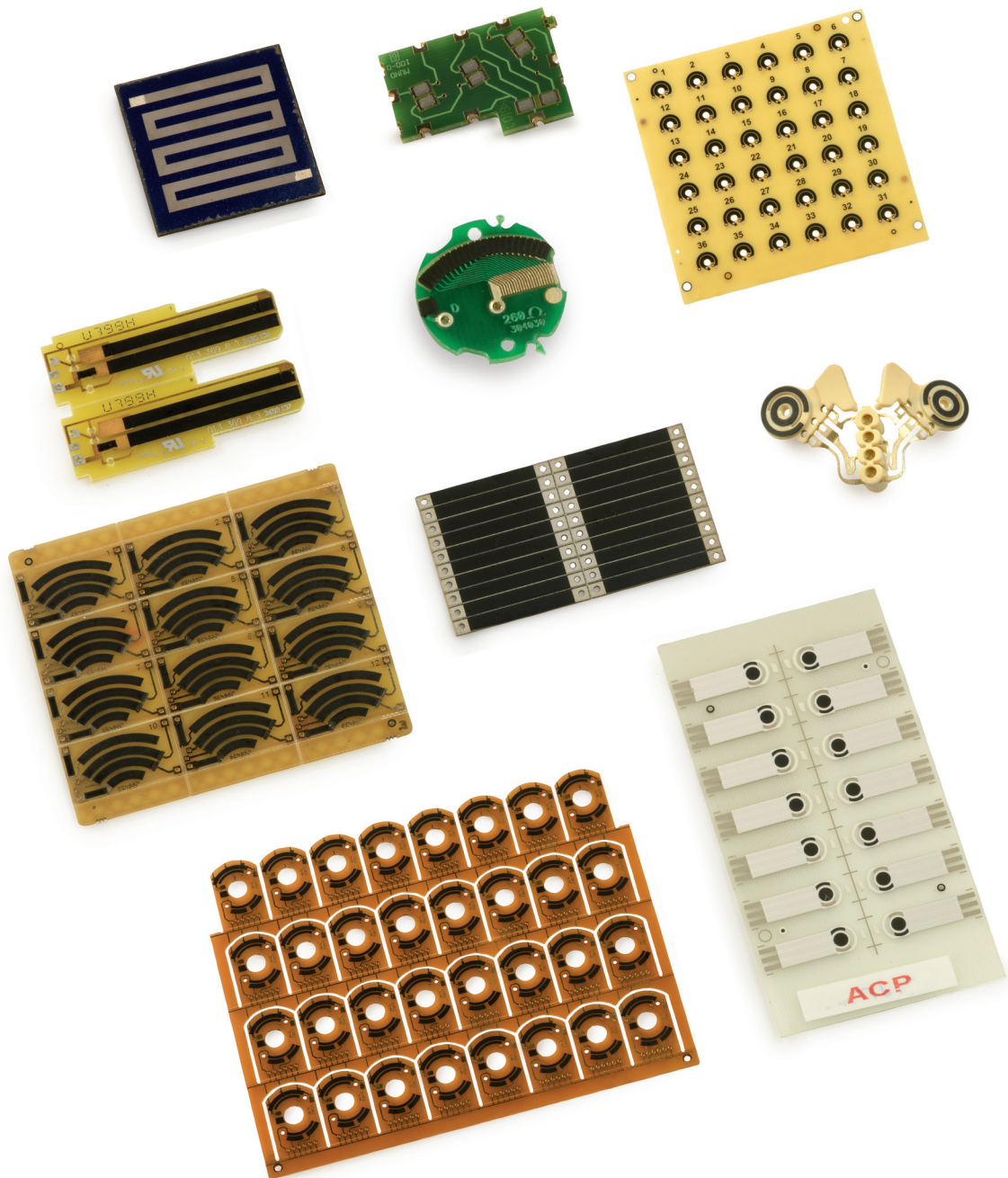

## THICK FILM SOLUTIONS

### PRINTED CIRCUIT RESISTORS

Thick Film Printed Circuit Resistors are screen printed layers of resistive, conductive and/or dielectric pastes deposited on different types of substrates, like FR, CEM, Alumina, Polyester, Polyimide, PA, Dielectric on Metal etc.

There are two basic technologies depending on the type of pastes applied: Carbon and Cermet, the latter needed on applications where high power dissipation is required or when resistor value stability at high temperatures is important.

Potentiometer Tracks is the type of Printed Circuit Resistors that ACP specializes in. This is one of our core competences and it is the heart of all our potentiometer families. Our know-how includes the expertise in the different technologies involved in the production process:

- Pastes and inks formulation and blending
- Screen printing in type C (class 10.000) clean room
- Curing or Sintering
- Laser trimming
- Automated testing

Design patterns and shapes are varied; every specific project has different geometrical requirements. We are able to process from single to multiple circuit panel configurations, with maximum panel dimensions of: 280mm - 180mm (Pattern 250mm x 150mm).

Let us know about your project and our engineers will propose the most suitable designs for each specific application. In many instances, mixed solutions where Potentiometer Tracks, Trimmed Fixed Resistors and Contact Switches are combined, make the most cost effective circuit design.

### Features

- Resistive element: Resistive blends from 10 to 1M Ohm/square allow for a wide range of resistive tracks and values.
- Tapers: Linear tapers with up to 1.8% independent linearity, step functions, logarithmic and antilog curves. Combination of potentiometer and on/off switches or symmetrical double track potentiometers.
- Tolerance: Laser trimming up to 1% of Rn.
- Minimum resistive track separation: Up to 0.3mm between adjacent tracks.
- Type of substrates: FR2, FR4, CEM1, CEM2, Polyester, Polyimide, Polyamide, Alumina.
- Mechanical life: The Mechanical Life performance depends on the interaction between the wiper and the resistive track contact surfaces. A balanced wear of both surfaces is key to guarantee the expected results. Several factors have an influence:
  - Wiper: Geometry, material, finishing, pressure, number of fingers, finger tip shape.
  - Inks: Type of ink, ink blend, materials contained and the process parameters when deposited and cured, geometry of the printed pad.
  - Speed of wiping slide cycle.
  - Climatic conditions: Working Temperature and Humidity. Thermal cycles: Temperature and humidity cycles.
  - Working environment.
  - Lubricants: They can help providing a good performance, however, they are not always needed.

A detailed and comprehensive understanding of the above parameters is fundamental in order to provide the adequate PCR track and substrate: We have solutions that range from 10.000 to 5.000.000 cycles under aggressive thermal and climate conditions.

### Applications

Applications where Potentiometer Tracks can be applied can be classified in two major types: 1) Position Sensors and 2) Switches & Controls. Examples in different markets are listed below:

#### Automotive and Vehicle Markets

Position Sensors: Feedback Potentiometers on HVAC Actuators, Side Mirror Memory Actuators, Throttle Sensors, Head Lamp Levelling Actuators, Fuel Tank Senders, Start-Stop, Steering Wheel Angle Sensor, Drive by Wire, Break by Wire, Seat Positioning Actuators, Adaptive Front Lighting, etc.

Switches and Controls: Climate Control Switches (Fan Speed, Temperature Setting, Air Flow Distribution), Head Lamp Levelling Switch, Dash Board Light Dimmer, Seat Heating Controls, Haptic Control, Light Switch, Airbag Enable/ Disable Switch, etc.

#### Industrial and Consumer Markets

Position Sensors: Feedback Potentiometers on different types of Actuators (HVAC, Window Blinds, Valve Controls,)

Switches and Controls: Joystick Controls, Speed Control of Professional Power Tools, DIY tools, Garden and Lawn Electric Tools.

### How to Order

Thick-Film solutions are customized. We kindly request a drawing with dimensions, electrical use, application, mechanical life and other significant data.

Please, send us your project specifications and we will send you our proposal.

# 5 Special potentiometers

# SPECIAL

## Potentiometers

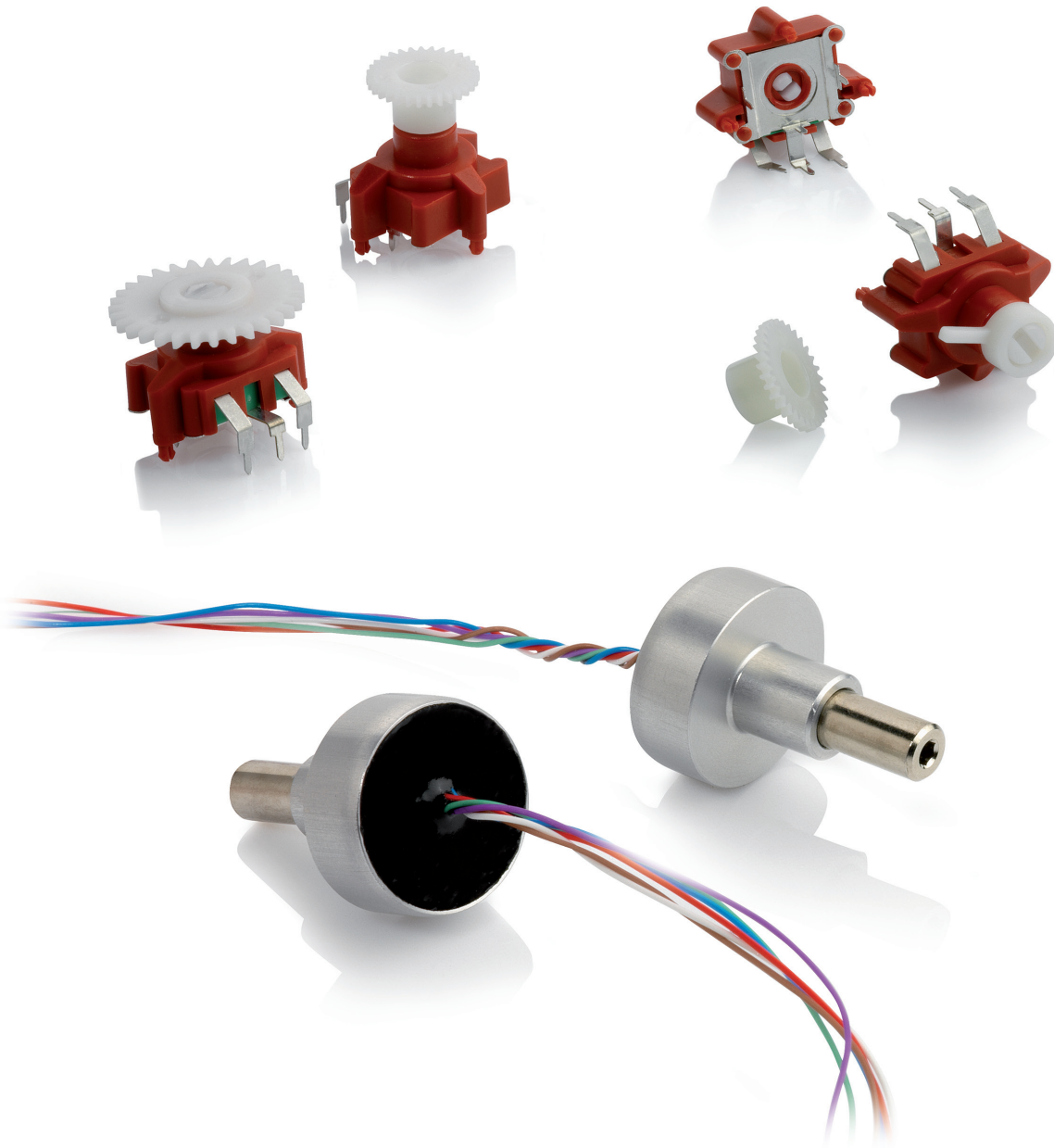

## METAL CASE

### POTENTIOMETER

Synchronized switch and potentiometer functions in a metal enclosure sealed with resin to secure IP 65 environmental protection.

Metal shaft with endless rotation.

Interface by means of wires.

More than 1 million turns mechanical life.

## GEARED POSITION

### SENSORS

Modified RS14 with special housing and pin layout.

Mechanical interface by means of different gears.

Up to 1.000.000 mechanical cycles.





**Aragonesa de Componentes Pasivos**

Poligono industrial, s/n  
P.O. Box 43 (Apartado de correos 43)  
E-50500 Tarazona - Zaragoza - Spain  
Tel.: (+34) 976 643 063  
(+34) 976 199 101  
Fax: (+34) 976 643 464  
[www.acptechnologies.com](http://www.acptechnologies.com)

Company certified by IQNet (Aenor) under:  
ISO 9001  
ISO/TS 16949